

STEREO POWER AMPLIFIER

M-60

SERVICE MANUAL

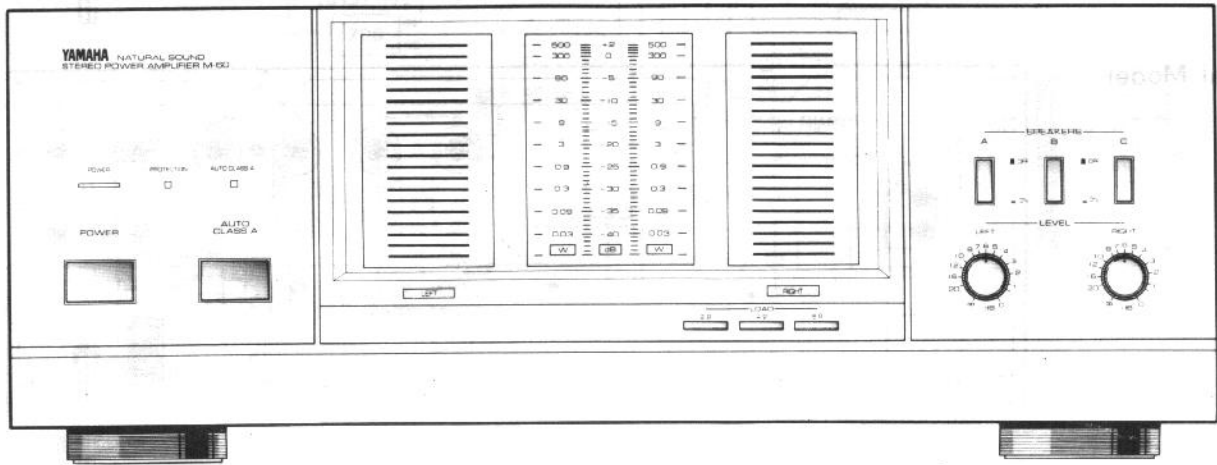

■ TO SERVICE PERSONNEL

1. Critical Components Information.

Components having special characteristics are marked \triangle and must be replaced with parts having specifications equal to those originally installed.

2. Leakage Current Measurement (For 120V Model Only).

When service has been completed, it is imperative that you verify that all exposed conductive surfaces are properly insulated from supply circuits.

- Meter impedance should be equivalent to 1500 ohm shunted by $0.15\mu\text{F}$.
- Leakage current must not exceed 0.5mA.
- Be sure to test for leakage with AC plug in both polarities.

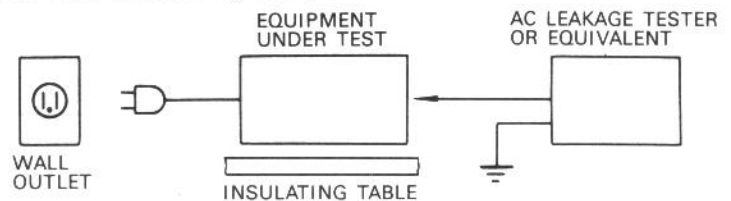

■ CONTENTS

REAR PANEL.....	1	P.C. BOARD ~ MAIN.....	6
BLOCK DIAGRAM.....	2	SCHEMATIC DIAGRAM ~ MAIN.....	8
SPECIFICATIONS.....	2	SCHEMATIC DIAGRAM ~ METER.....	9
INTERNAL VIEW.....	3	WIRING DIAGRAM.....	9
DISASSEMBLY INSTRUCTIONS.....	3	PARTS LIST ~ ELECTRIC.....	10
ADJUSTMENTS.....	4	EXPLODED VIEW ~ MECHANISM/CHASSIS.....	14
P.C. BOARD ~ METER.....	5	PARTS LIST ~ MECHANISM/CHASSIS.....	16

004560

SINCE 1887



YAMAHA

NIPPON GAKKI CO., LTD. HAMAMATSU, JAPAN

2.6K-781 Ⓛ Printed in Japan 84.7

PRINTED CIRCUIT BOARD PATTERN SIDE - MAIN CIRCUIT BOARD

INTERNAL VIEW

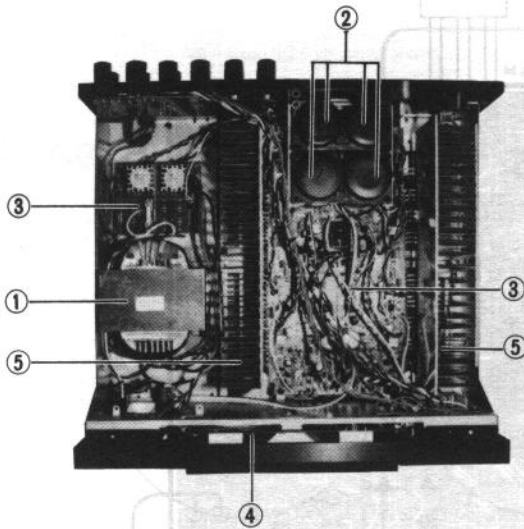

- ① Power Transformer
- ② Electrolytic Cap
- ③ Main P.C.B.
- ④ Meter P.C.B.
- ⑤ Heat Sink

ADJUSTMENTS

Before Adjustments

- Wait 2 minutes after power-ON to stabilize amplifier operation.
- Make sure that the main volume is minimum and set Auto-A switch to OFF.

Step	Adjustments	Location	Test Equipment	Test point	Value
1	Idling adjustment	VR103(L-ch.) VR104(R-ch.)	D.C. V-meter Digital tester	Across emitter resistor (0.22Ω) of power transistor. R153,R155(L-ch.) R154,R156(R-ch.)	10.0±1mV
2	Auto-A operation confirmation	Check that the voltage at each test point stated above increases when Auto-A switch is turned on.			110±10mV
3	Meter Level adjustment	VR501(L-ch.) VR502(R-ch.)	(1) Set the load level of the meter at 2Ω position. (2) Adjust VR501 and VR502 so that 0dB of the meter lights up when the output is f=1KHz and V=34.5V.		

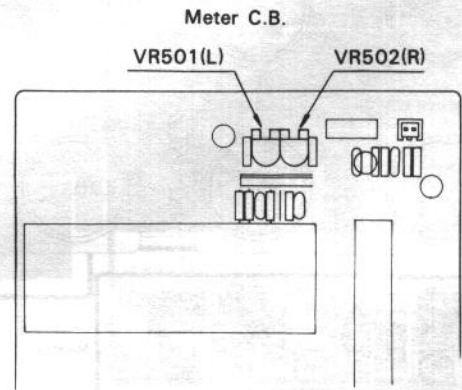
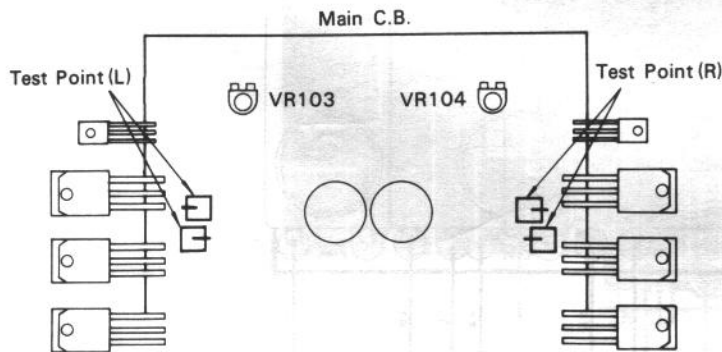

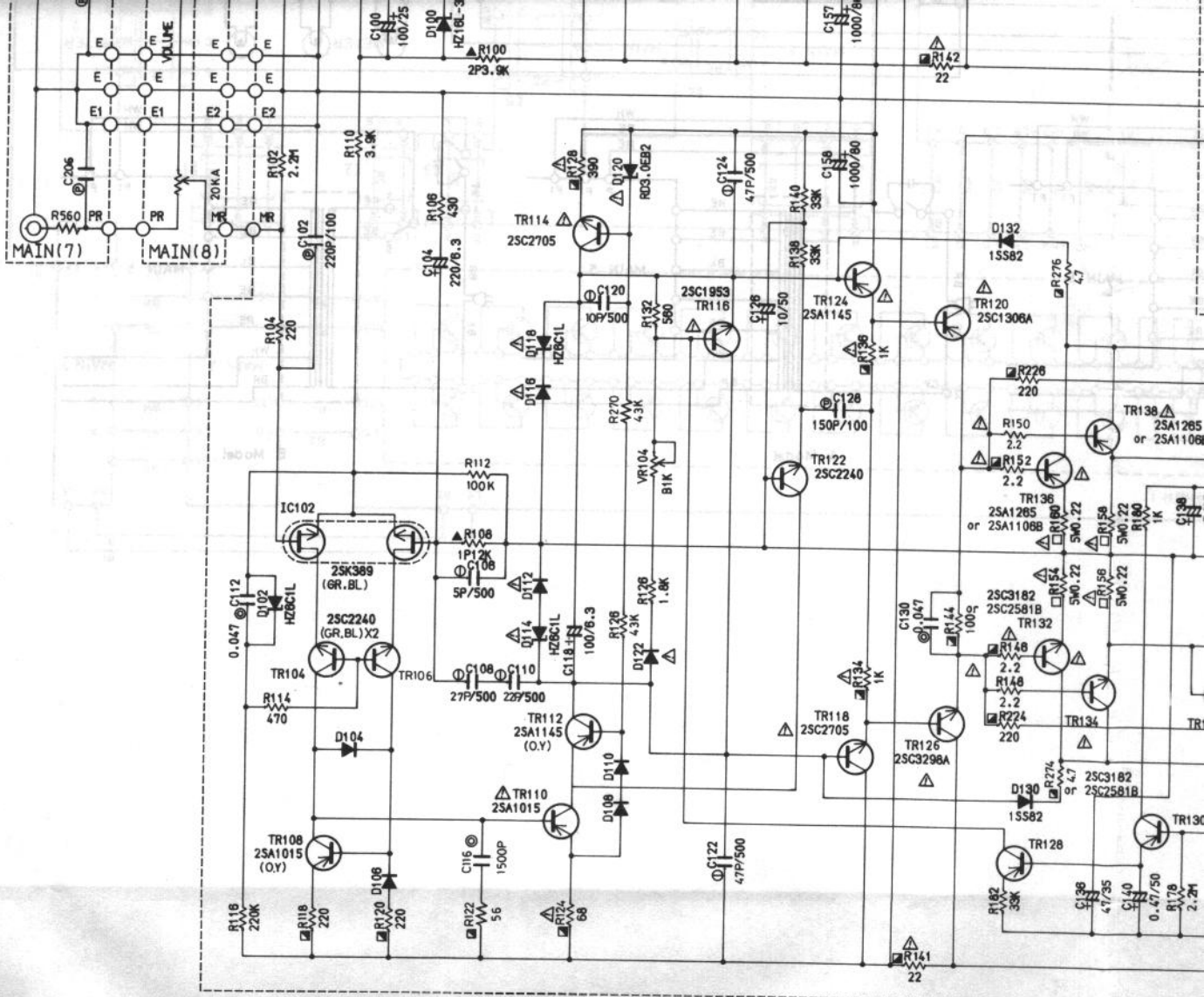

CAPACITOR

REMARKS	PARTS NAME	
NO MARK	ELECTROLYTIC CAPACITOR	#
NO MARK	CERAMIC CAPACITOR	
⊙	POLYESTER FILM CAPACITOR	
○	POLYSTYRENE FILM CAPACITOR	
⊖	MICA CAPACITOR	
⊕	POLYPROPYLENE FILM CAPACITOR	

RESISTOR

REMARKS	PARTS NAME
NO MARK	CARBON FILM RESISTOR
△	METAL OXIDE FILM RESISTOR
▲	METAL FILM RESISTOR
⊠	METAL PLATE RESISTOR
■	FIRE PROOF CARBON FILM RESISTOR
⊗	SEMI VARIABLE RESISTOR

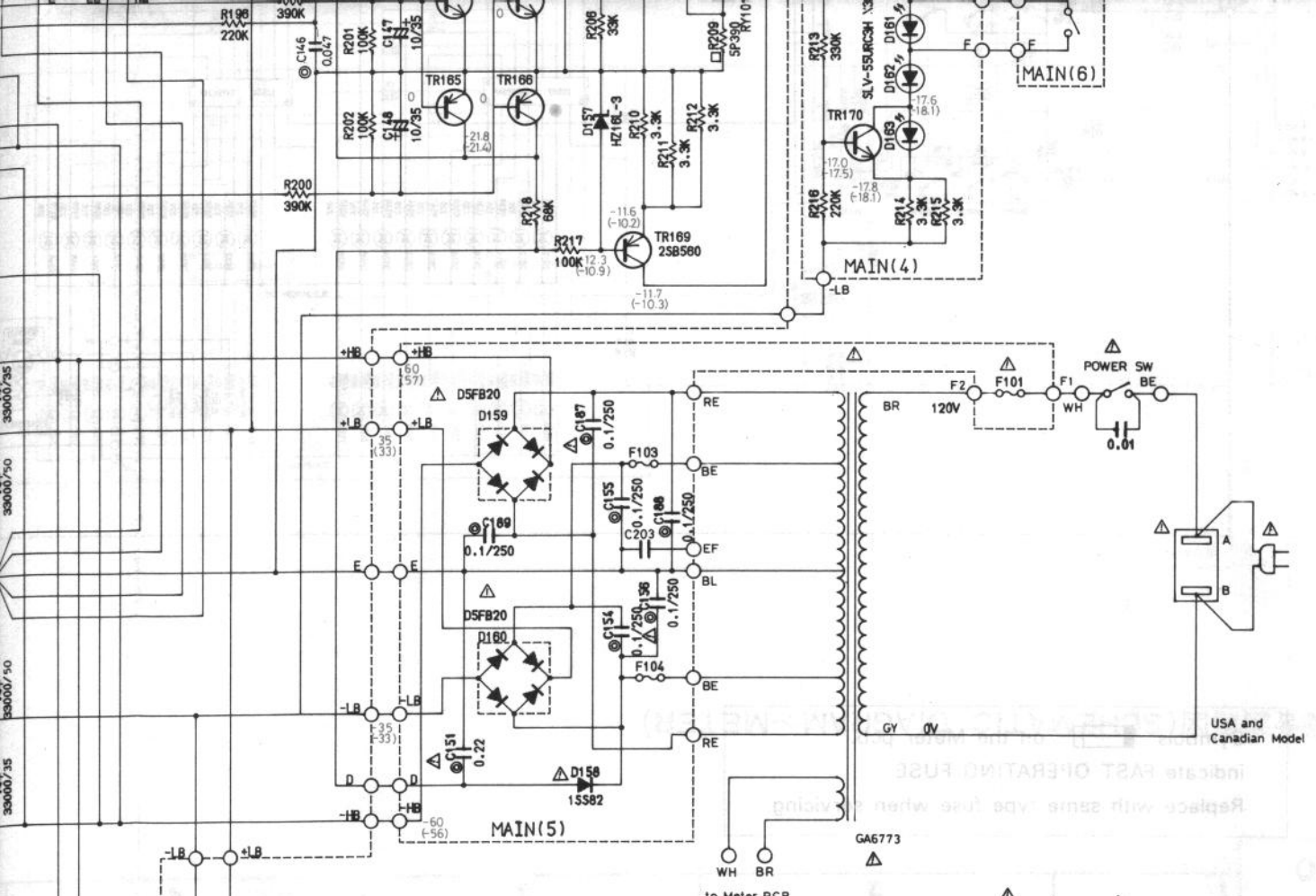

AC IN	CONNECT (Terminal No.)	
100V	5-4	2-1
120V	6-5	3-2
220V	7-1	8-4
240V	7-6	8-3

(7-8) . . Ext. short

	U.C	R	A.E
C154	0.1/250	0.1/250	OPEN
C155	OPEN	OPEN	0.1/250
C156	OPEN	OPEN	0.1/250
C187	0.1/250	0.1/250	OPEN
C188	OPEN	OPEN	0.1/250
C189	OPEN	OPEN	0.1/250
F101	15A250V	15A250V	T8.3A250V
F102		T7.0A250V	
F103			T8.3A250V
F104			T8.3A250V
C201 -203	OPEN	OPEN	0.01
C195 -200	OPEN	OPEN	2700P / 100

TO METER

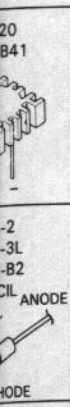

to Meter PCB

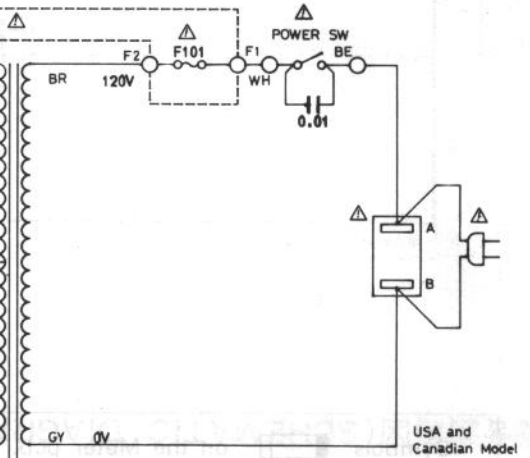

USA and Canadian Model

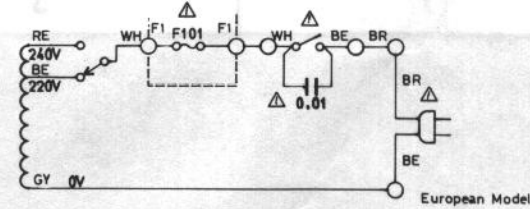

European Model

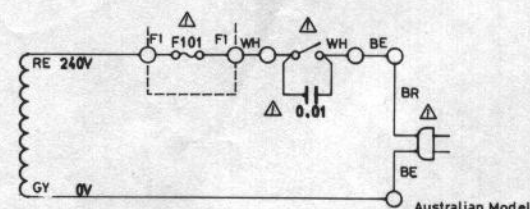

Australian Model

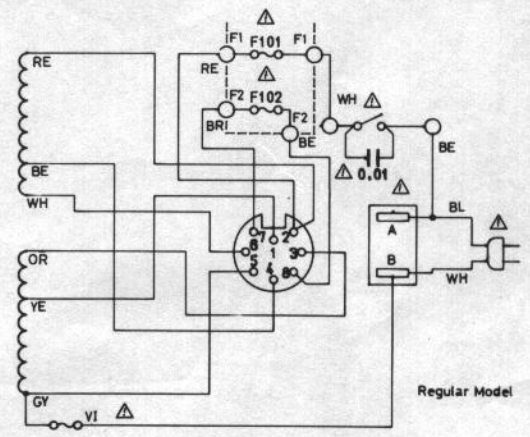

Regular Model

■ WARNING

Components having special characteristics are Marked  and must be replaced with parts having specifications equal to those originally installed.

- All voltage are measured with a 10M Ω /V DC electric volt meter.
- Schematic diagram is subject to change without notice.

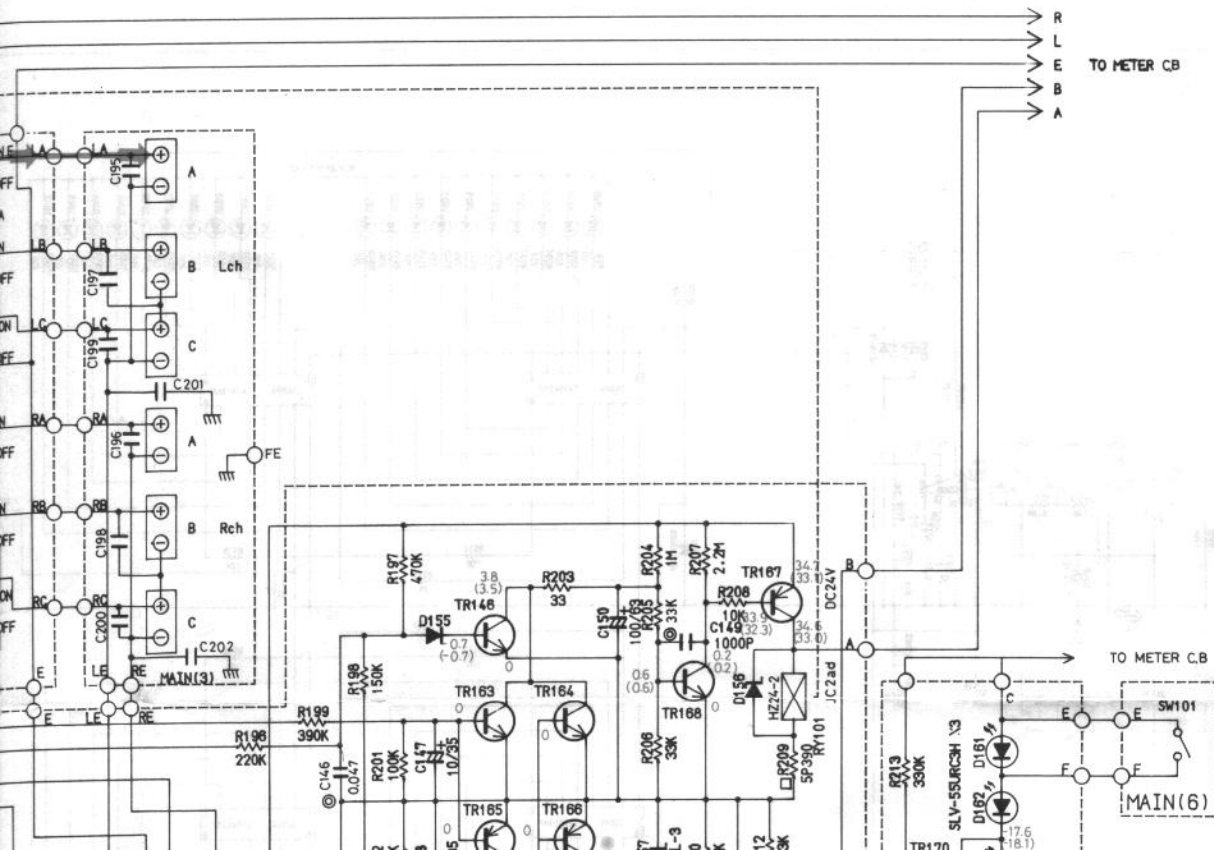

- Confirmation of the voltage switching operation.
 Terminals output : $f=1\text{KHz}$ 100W (load is 8Ω).
 Check that the wave form at $\pm\text{LP}$ and $\pm\text{RP}$ terminals changes as shown below.

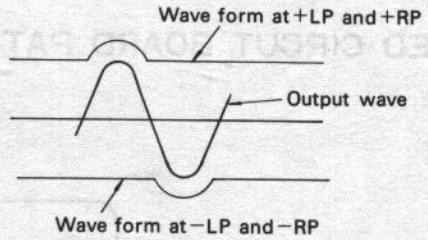

A B C D

■ PRINTED CIRCUIT BOARD PATTERN SIDE ~ METER CIRCUIT BOARD

1
2
3
4
5

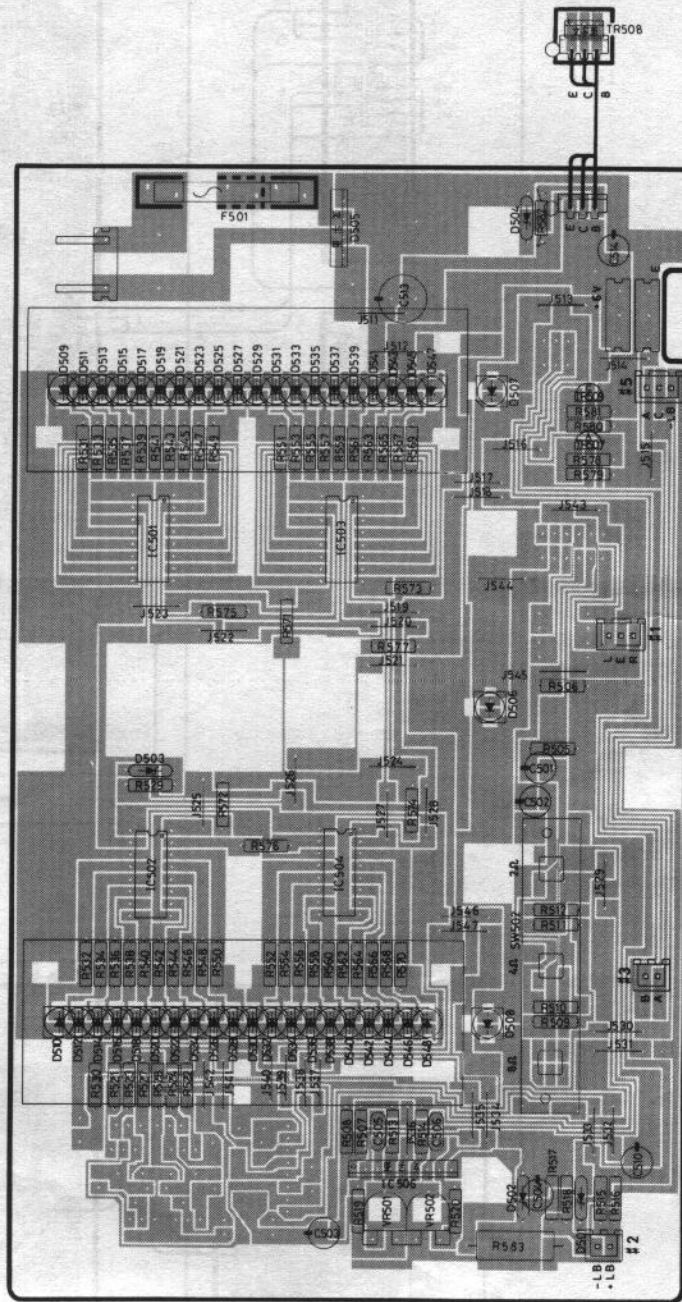

CSA

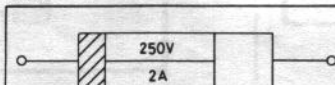

Symbols on the Meter pcb indicate FAST OPERATING FUSE.
 Replace with same type fuse when servicing.

PRINTED CIRCUIT BOARD PATTERN SIDE ~ MAIN CIRCUIT BOARD

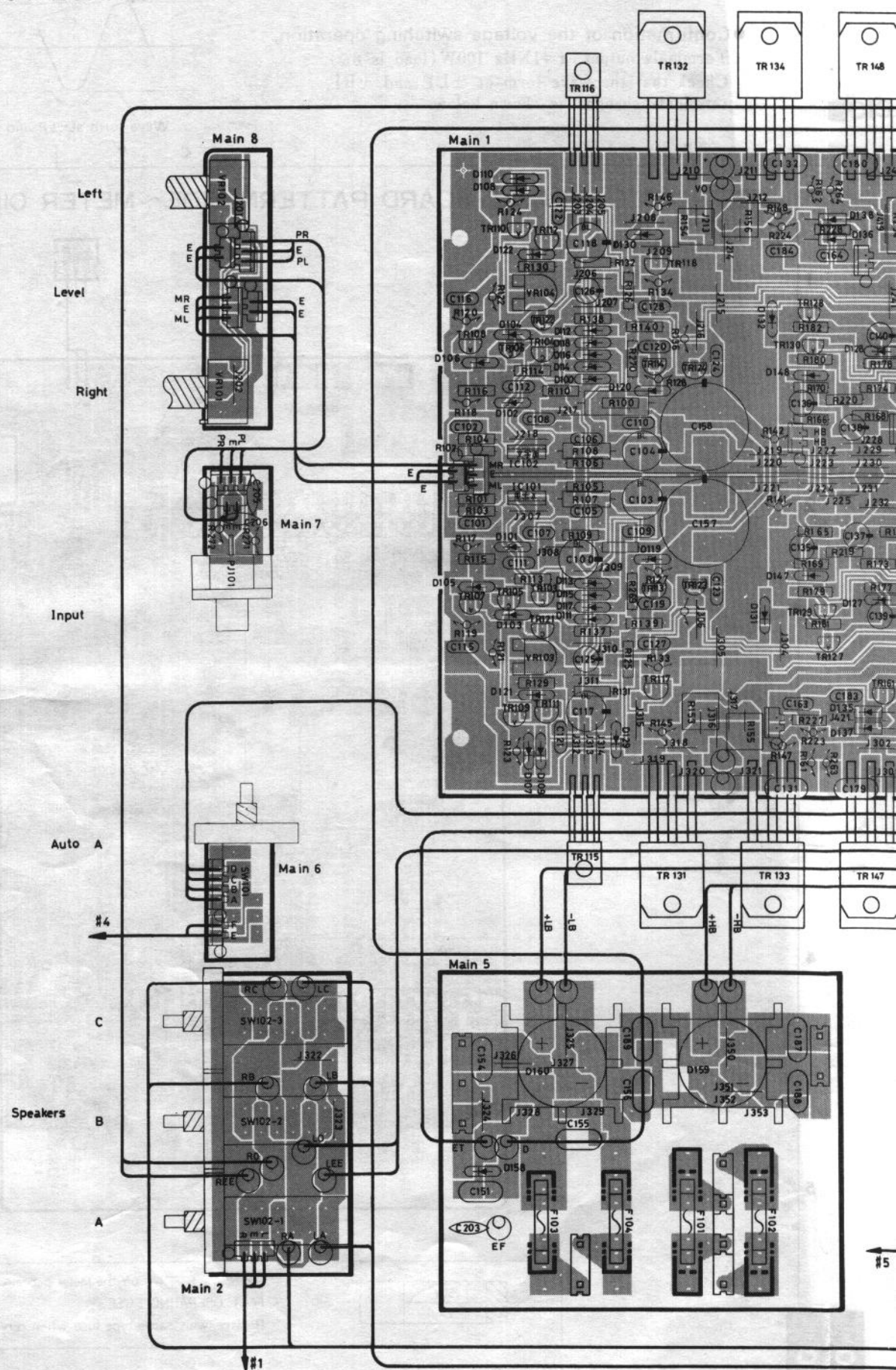

INTERNAL VIEW

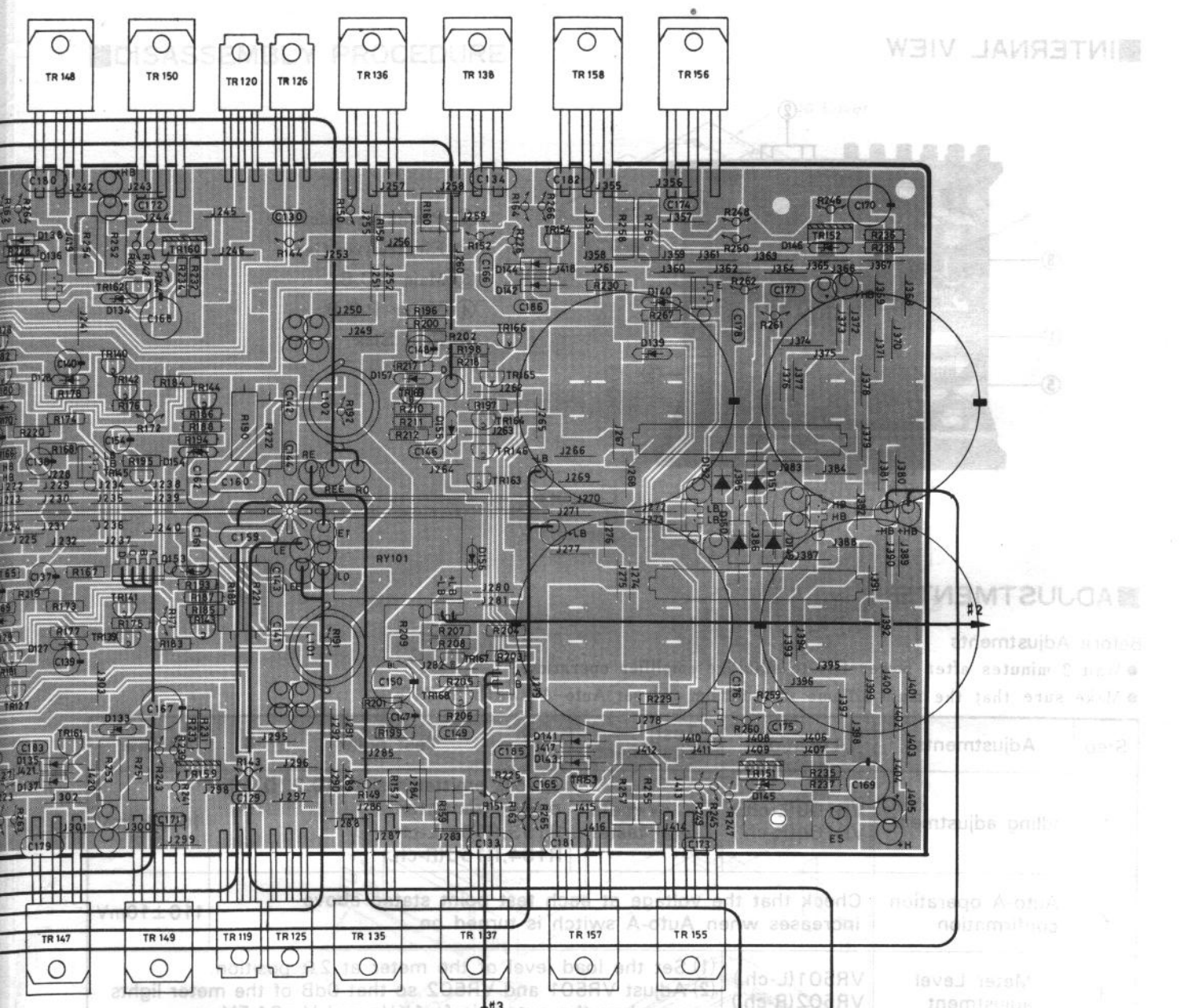

Main 3

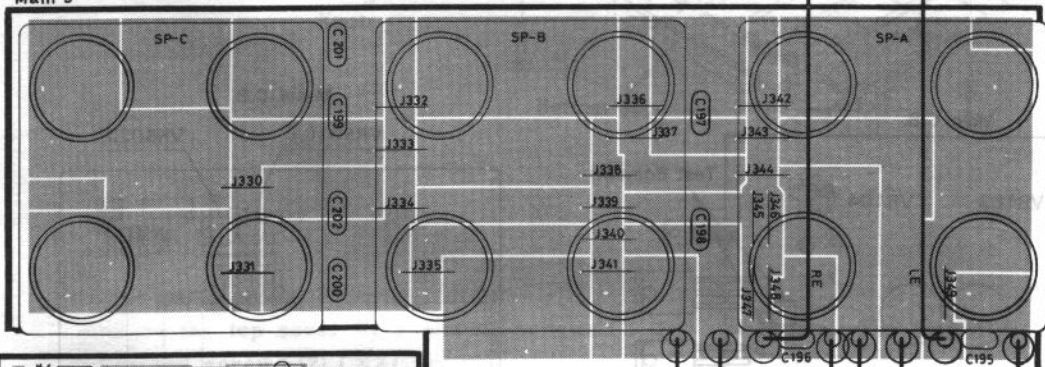

Main 4

