

SERVICE MANUAL

CA-1010

STEREO PRE/MAIN AMPLIFIER

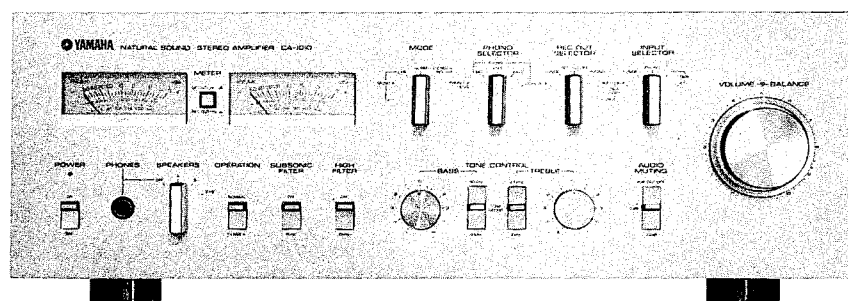

SINCE 1887



YAMAHA

NIPPON GAKKI CO., LTD. HAMAMATSU, JAPAN

CONTENTS

PANEL OPERATION	
● FRONT PANEL	1
● REAR PANEL: US. AND GENERAL EXPORT MODEL	2
● REAR PANEL: EUROPEAN AND AUSTRALIAN MODEL	3
SPECIFICATIONS	4
CHARACTERISTICS	5
BLOCK DIAGRAM	6
INTERNAL VIEW	
● TOP VIEW	7
● BOTTOM VIEW	8
DISASSEMBLY PROCEDURES	
● FLOW CHART	9
● PHOTO-1 ~ PHOTO-4	10
● PHOTO-5 ~ PHOTO-7	11
● PHOTO-8 ~ PHOTO-10	12
● PHOTO-11, PHOTO-12	13
PRINTED CIRCUIT BOARDS	
● POWER SUPPLY CIRCUIT BOARD	14
● ELECTROLYTIC CAPACTIRO CIRCUIT BOARD	15
● FUNCTION CIRCUIT BOARD, METER LAMP CIRCUIT BOARD	16
● TONE CONTROL CIRCUIT BOARD	17
● MAIN CIRCUIT BOARD	18
● METER CIRCUIT BOARD	19
● COUPLER CIRCUIT BOARD	19
ADJUSTMENT	
● FUNCTION CIRCUIT BOARD	20
● METER CIRCUIT BOARD	20
● MAIN CIRCUIT BOARD	21
SHEMATIC DIAGRAM BY EXPORT ZONE	22
SHEMATIC DIAGRAM	23
WIRING	24
PACKAGE	25

PANEL OPERATION

FRONT PANEL

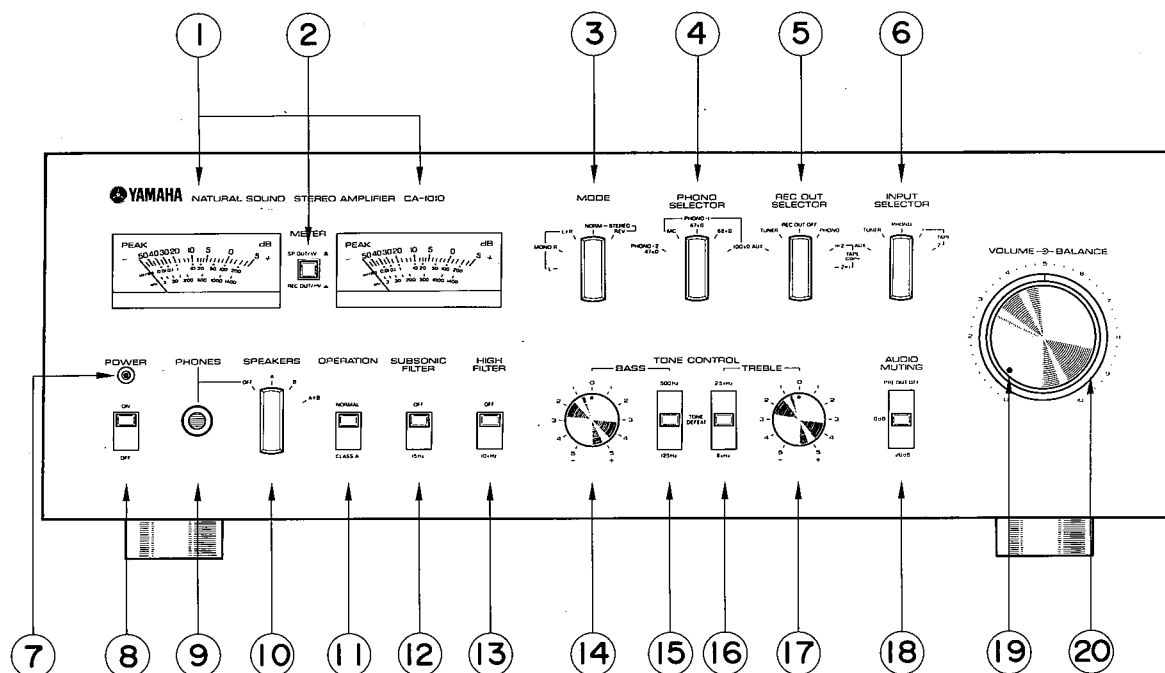

- ① METER (LEVEL MONITER)
- ② METER SWITCH (REC OUT – SP OUT)
- ③ MODE (STEREO, MONAURAL, LEFT/RIGHT EXCHANGE)
- ④ PHONO SELECTOR (MC HEAD AMP, INPUT IMPEDANCE SWITCHING)
- ⑤ REC OUT SELECTOR (RECORDING OUTPUT SELECTION AND TAPE DUBBING)
- ⑥ INPUT SELECTOR
- ⑦ POWER INDICATER
- ⑧ POWER SWITCH
- ⑨ PHONES (HEADPHONE JACK)
- ⑩ SPEAKERS (SPEAKER SELECTION)
- ⑪ OPERATION (A-/B-CLASS SELECTION)
- ⑫ SUBSONIC FILTER (LOW CUT FILTER)
- ⑬ HIGH FILTER (HIGH CUT FILTER)
- ⑭ BASS (BASS CONTROL)
- ⑮ TONE DEFEAT, TURN OVER SWITCH (BASS)
(BASS CONTROL DEFEAT, TURN OVER FREQUENCY SELECTION)
- ⑯ TONE DEFEAT, TURN OVER SWITCH (HIGH)
(TREBLE CONTROL DEFEAT, TURN OVER FREQUENCY SELECTION)
- ⑰ TREBLE (TREBLE CONTROL)
- ⑱ AUDIO MUTING (ATTNUATING CIRCUIT CONTROL, -20dB)
- ⑲ VOLUME (VOLUME LEVEL ADJUSTMENT)
- ⑳ BALANCE

PANEL OPERATION

REAR PANEL: U.S. AND GENERAL EXPORT MODELS

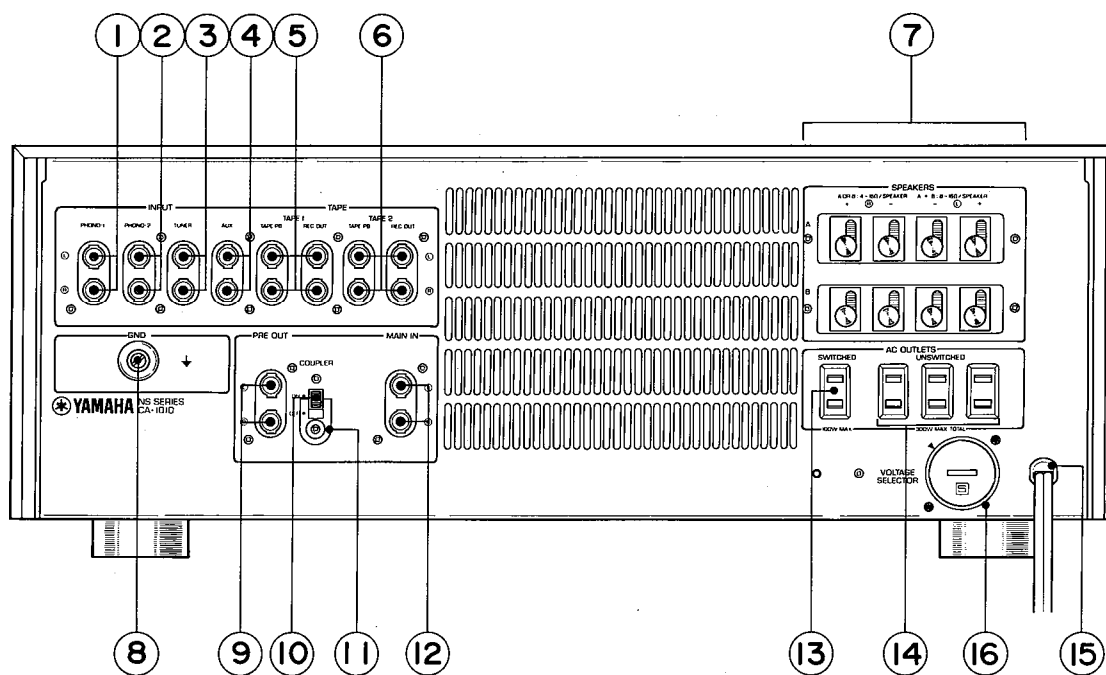

- ① PHONO-1 (PHONO INPUT TERMINAL)
- ② PHONO-2 (PHONO INPUT TERMINAL)
- ③ TUNER (TUNER INPUT TERMINAL)
- ④ AUX (AUXILIARY INPUT TERMINAL)
- ⑤ TAPE-1 (TAPE-1: RECORDING AND PLAY BACK TERMINAL)
- ⑥ TAPE-2 (TAPE-2: RECORDING AND PLAY BACK TERMINAL)
- ⑦ SPEAKERS (SPEAKER OUTPUT TERMINAL)
- ⑧ GND (EARTH TERMINAL)
- ⑨ PRE OUT (PRE AMP. OUTPUT TERMINAL)
- ⑩ COUPLER (PRE/MAIN DISCONNECTION)
- ⑪ STOPPER (COUPLER SWITCH STOPPER)
- ⑫ MAIN IN (MAIN AMP INPUT TERMINAL)
- ⑬ AC OUTLET (SWITCHED: INTERLOCKED WITH POWER SWITCH. MAX 100W)
- ⑭ AC OUTLETS (UNSWITCHED: NOT INTERLOCKED WITH POWER SWITCH. MAX 300W)
- ⑮ AC CORD (AC POWER CORD)
- ⑯ VOLTAGE SELECTOR (General Export Models Only)

PANEL OPERATION

REAR PANEL: EUROPEAN AND AUSTRALIAN MODELS

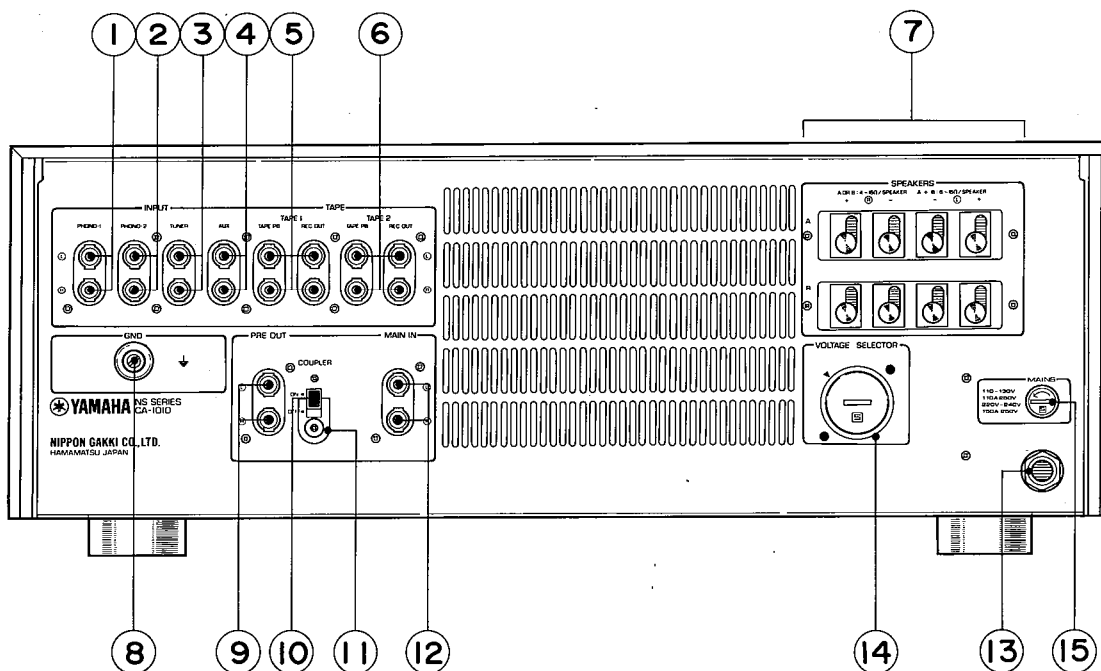

- ① PHONO-1 (PHONO INPUT TERMINAL)
- ② PHONO-2 (PHONO INPUT TERMINAL)
- ③ TUNER (TUNER INPUT TERMINAL)
- ④ AUX (AUXILIARY INPUT TERMINAL)
- ⑤ TAPE-1 (TAPE-1: RECORDING AND PLAY BACK TERMINAL)
- ⑥ TAPE-2 (TAPE-2: RECORDING AND PLAY BACK TERMINAL)
- ⑦ SPEAKERS (SPEAKER OUTPUT TERMINAL)
- ⑧ GND (EARTH TERMINAL)
- ⑨ PRE OUT (PRE AMP. OUTPUT TERMINAL)
- ⑩ COUPLER (PRE/MAIN DISCONNECTION)
- ⑪ STOPPER (COUPLER SWITCH STOPPER)
- ⑫ MAIN IN (MAIN AMP. INPUT TERMINAL)
- ⑬ CORD STOPPER (AC POWER CORD)
- ⑭ VOLTAGE SELECTOR
- ⑮ FUSE HOLDER (MINIATURE FUSE) European Model Only

SPECIFICATIONS

OUTPUT 20Hz 20KHz	
B-CLASS 8Ω	100W + 100W (0.02% AUX IN)
B-CLASS 4Ω	120W + 120W (0.02% AUX IN)
B-CLASS 8Ω	20W + 20W (0.02% AUX IN)
POWER BAND WIDTH	
B-CLASS 8Ω	10Hz ~ 50KHz (0.02%)
A-CLASS 8Ω	10Hz ~ 70KHz (0.02%)
	45 or more
DAMPING FACTOR (1KHz, 8Ω)	
DISTORTION	
PHONO 1, 2	0.003% or less (REC OUT 5V, 20Hz ~ 20KHz)
MC	0.03% or less (REC OUT 3V, 20Hz ~ 20KHz)
TUNER, AUX	0.005% or less (REC OUT 3V, 20Hz ~ 20KHz)
MAIN IN B-CLASS	0.01% or less (SP OUT 50W, 8Ω, 20Hz ~ 20KHz)
A-CLASS	0.005% or less (SP OUT 10W, 8Ω, 20Hz ~ 20KHz)
TUNER-SP OUT B-CLASS	0.01% or less 50E, 8Ω, 20Hz ~ 20KHz)
PHONO-SP OUT	
PHONO USERBLE	0.1% VOL-20dB, 0.4W 90W, 23.5dB
DYNAMIC RANGE	-66dB, VOL-40dB, 0.04W 90W, 33.5dB
NOISE LEVEL S/N	
PHONO 1, 2	82dB (IHF A NETWORK), -134dBm
MC	65dB (IHF A NETWORK, INPUT 0Ω SHORT-CIRCUITED), -163dBm
	68dB (IHF A NETWORK, INPUT 50Ω SHORT-CIRCUITED), -166dBm
TUNER, AUX, TAPE	100dB (IHF A NETWORK), -116dBm
MAIN	115dB (IHF A NETWORK), -113dBm
	0.1mV or less
RESIDUAL NOISE	
INPUT TERMINAL	
PHONO 1	2mV/47K, 68K, 100KΩ
PHONO 2	2mV/47KΩ
MC	50μV/10Ω
TUNER, AUX	120mV/50KΩ
MAIN IN	1V/25KΩ
MAX. ALLOWABLE INPUT (1KHz, 0.02% DISTORTION)	
PHONO 1	310mV or less
PHONO 2	310mV or less
MC	7.5mV or less
TUNER, AUX	20mV or less
OUTPUT TERMINAL (OUTPUT LEVEL REC OUT /IMPEDANCE)	
REC OUT	120mV/600Ω
REC OUT	1V/500Ω
MAX. OUTPUT (1KHz, 0.02% DISTORTION)	
REC OUT	18.6V
REC OUT	7V
FREQUENCY CHARACTERISTICS	
PHONO 1, 2, MC	30Hz ~ 15KHz (0±0.2dB, RIAA DEVIATION)
TUNER-PRE OUT	15Hz 100KHz (+0 -1dB)
TUNER-SP OUT	5Hz ~ 50KHz (+0 -1dB, 8Ω LOAD)
TONE CONTROL	
BASS	TURNOVER 125Hz
	500Hz (20Hz ± 10dB VARIABLE)
TREBLE	TURNOVER 88KHz
	2.5KHz (20Hz ± 10dB VARIABLE)
FILTER	
SUB SONIC FILTER	15Hz, 12dB/OCT
HIGH FILTER	10KHz, 12dB/OCT
PEAK METER	
RISING TIME	100μ sec.
DROPPING TIME	0.95 sec.
DIMENSIONS	461(W) x 360(D) x 170(H)mm 18-5/32(W) x 14-3/16(D) x 6-11/16(H)in.
WEIGHT U.S. MODEL	19Kg 41.8 lbs
EUROPEAN MODEL	20Kg 44.0 lbs
RATED POWER CONSUMPTION	
U.S. & CANADIAN MODEL	600W, 700VA
EUROPEAN MODEL	900W
ACCESSORIS	
HEXAGONAL ALLEN WRENCH	1
PIN PLUG CORDS	1
• SPECIFICATIONS AND APPEARANCE ARE SUBJECT TO CHANGE WITHOUT NOTICE.	

CHARACTERISTICS

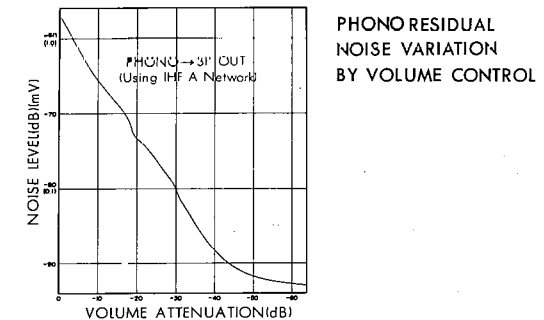
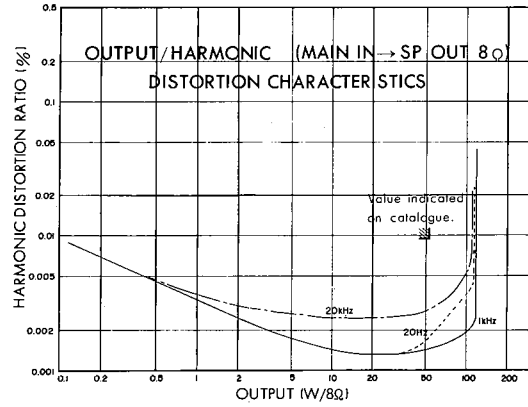
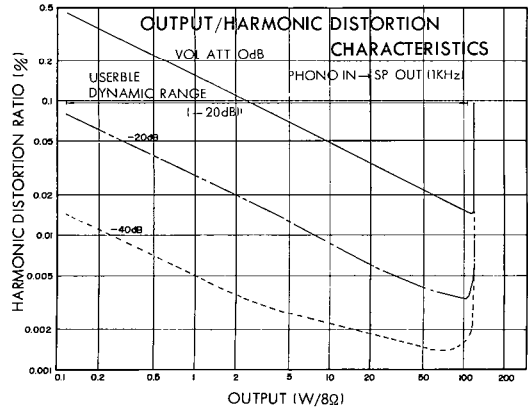
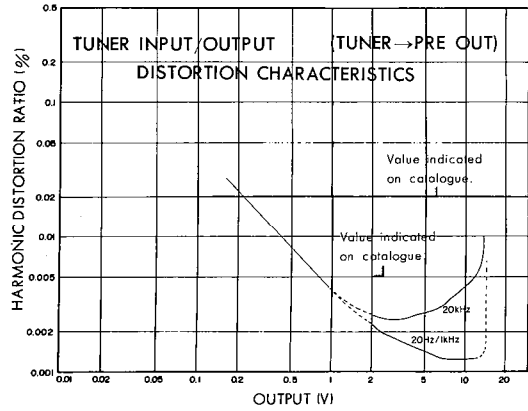
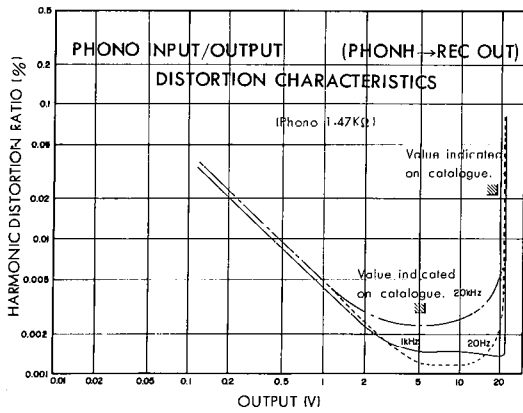
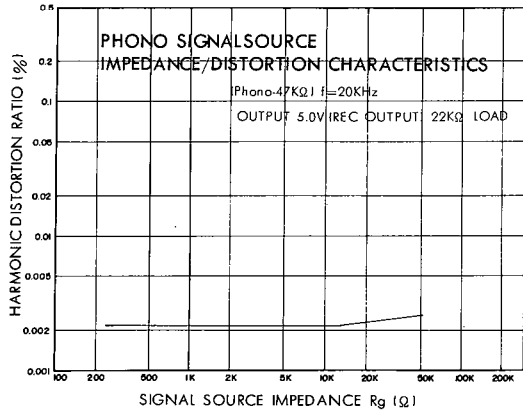
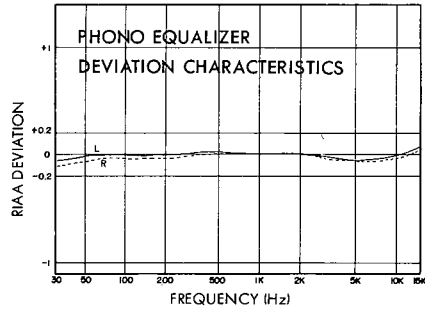
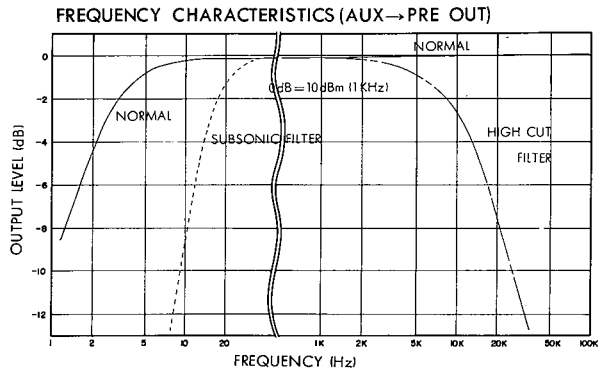

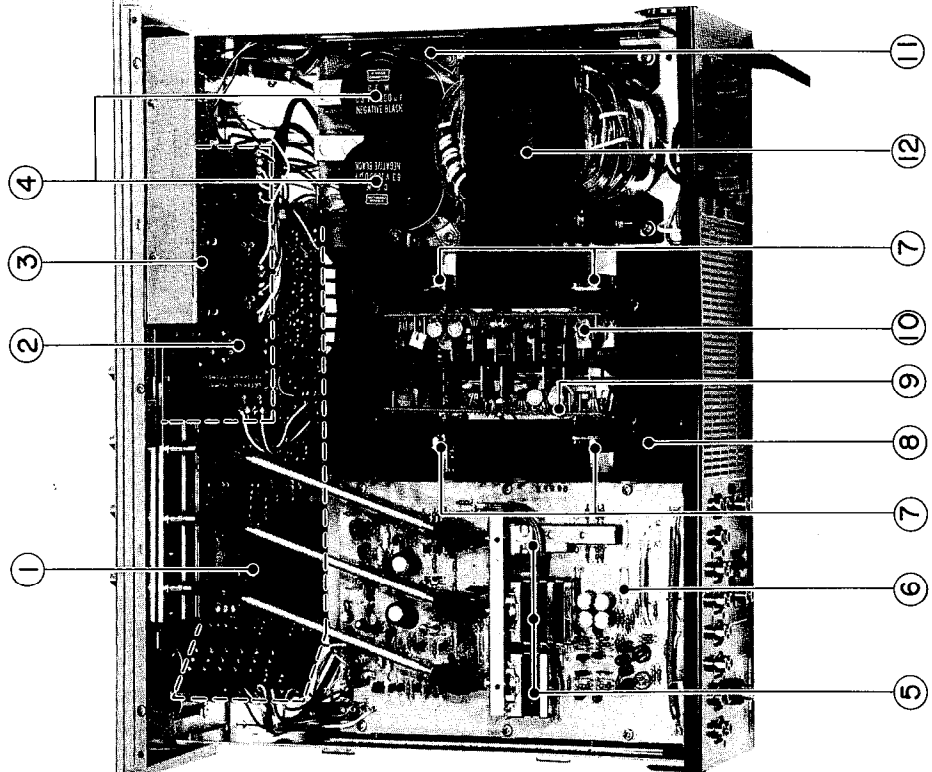

- ① TONE CONTROL CIRCUIT BOARD
- ② BASS CONTROL VR.
- ③ TREBLE CONTROL VR.
- ④ ELECTROLYTIC CAPACITOR CIRCUIT BOARD (18000 μ F/63wv)
- ⑤ TAP SWITCH
- ⑥ PROTECTION CIRCUIT BOARD
- ⑦ POWER TRANSISTOR
- ⑧ MAIN CIRCUIT BOARD
- ⑨ MAIN CIRCUIT BOARD (R)
- ⑩ MAIN CIRCUIT BOARD (L)
- ⑪ ELECTROLYTIC CAPACITOR CIRCUIT BOARD
- ⑫ POWER TRANSFORMER

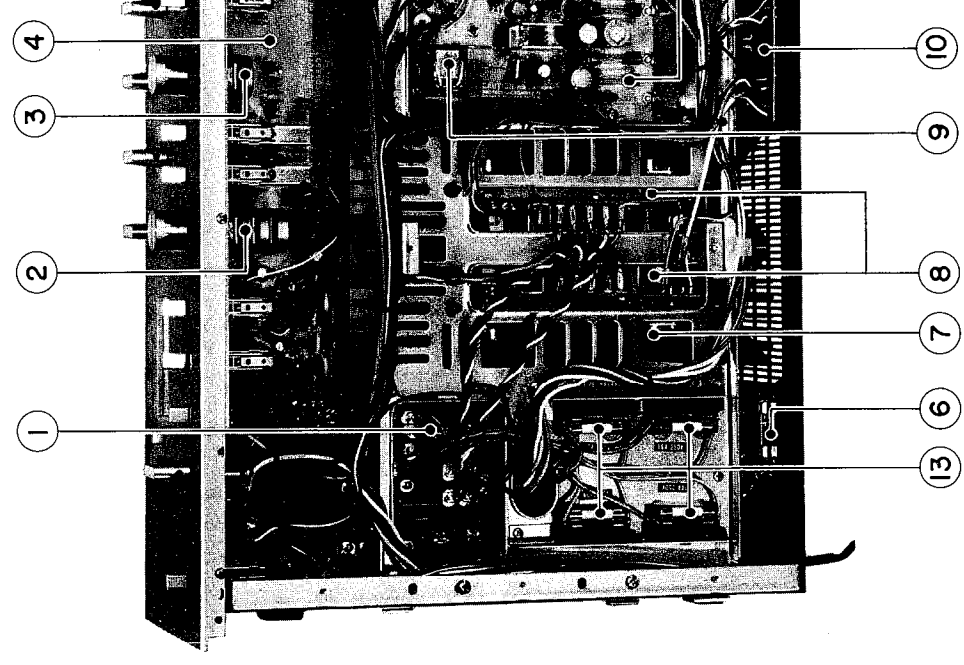

- ① ELECTROLYTIC CAPACITOR CIRCUIT BOARD
- ② BASS CONTROL VR.
- ③ TREBLE CONTROL VR.
- ④ TONE CONTROL CIRCUIT BOARD
- ⑤ VOLUME VALANCE VR.
- ⑥ AC FUSE
- ⑦ POWER TRANSISTOR
- ⑧ MAIN CIRCUIT BOARD
- ⑨ PROTECTION CIRCUIT RELAY
- ⑩ COUPLER CIRCUIT BOARD
- ⑪ POWER SUPPLY CIRCUIT BOARD
- ⑫ B-POWER FUSE F401 ~ 406

DISASSEMBLY PROCEDURES

FLOW CHART

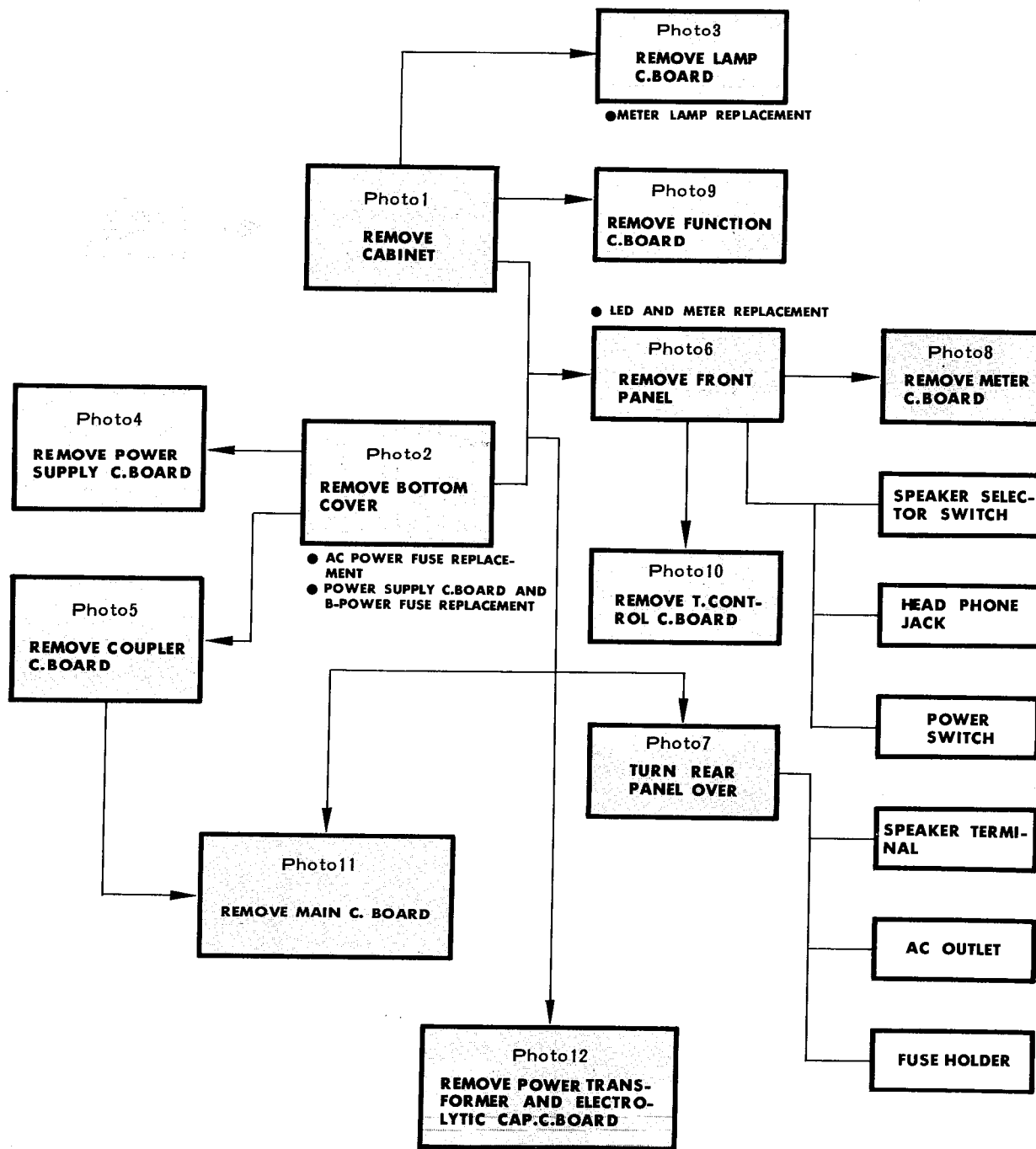

GUIDE TO FLOW CHART

To remove the required part, disassemble in the sequence of reversed arrowed direction. For example, in case of the MAIN c. board, it is required to remove the bottom cover, cabinet and coupler c. board. Other-

wise, you cannot disassemble smoothly. Adjustment 1 to 3 later described in this manual can be made after removing the cabinet shown in Photo 1.

DISASSEMBLY PROCEDURES

PHOTO 1 REMOVING THE CABINET

Remove four painted screws on both sides.
Shift the cabinet about 1cm in arrowed direction and lift the cabinet up for removal.

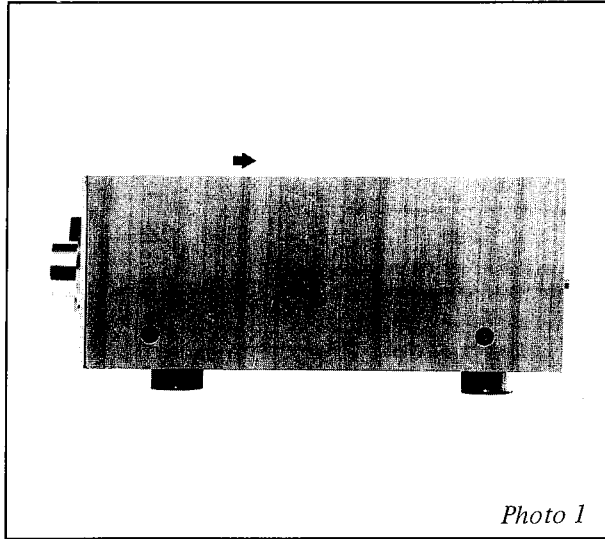
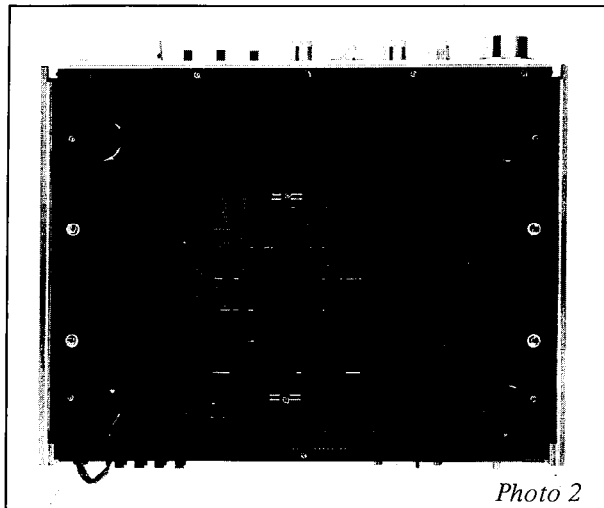

PHOTO 2 REMOVING THE BOTTOM COVER

Remove nine screws.



Under condition shown above, AC power fuse and B — Power fuses F401 to F406 on the power supply c. board can be replaced.

PHOTO 3 REMOVING THE METER LAMP C. BOARD

Remove two plastic rivets.

The two plastic rivets can be withdrawn forward while contracting umbrella-shaped portions of rivets on the rear side of the printed circuit board.

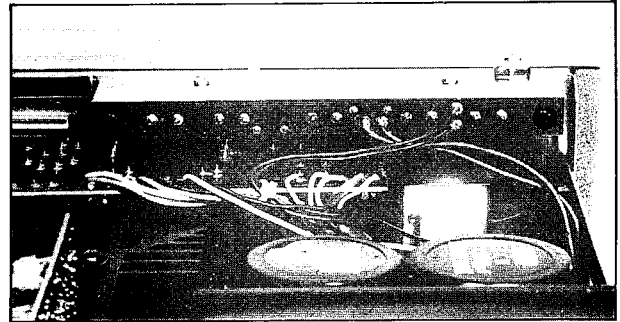

- At this time, the meter lamp can be replaced.

PHOTO 4 REMOVING THE POWER SUPPLY C. BOARD

Remove four screws, and then level the power supply c. board as shown for convenience of checking.

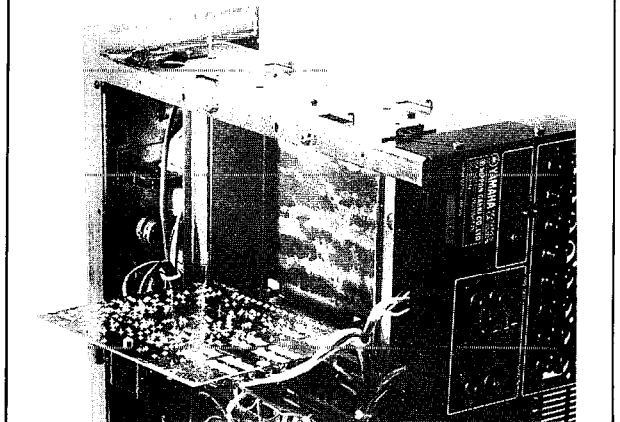
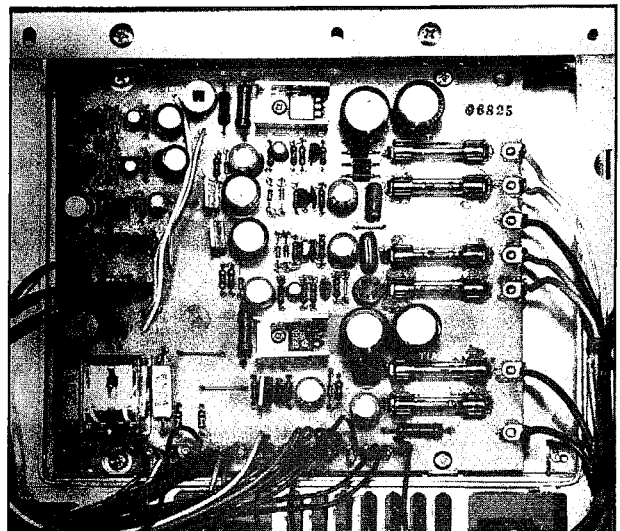

DISASSEMBLY PROCEDURES

PHOTO 5 REMOVING THE COUPLER C. BOARD

Remove four screws shown by arrow B, then dismantle the coupler c. board inwardly.

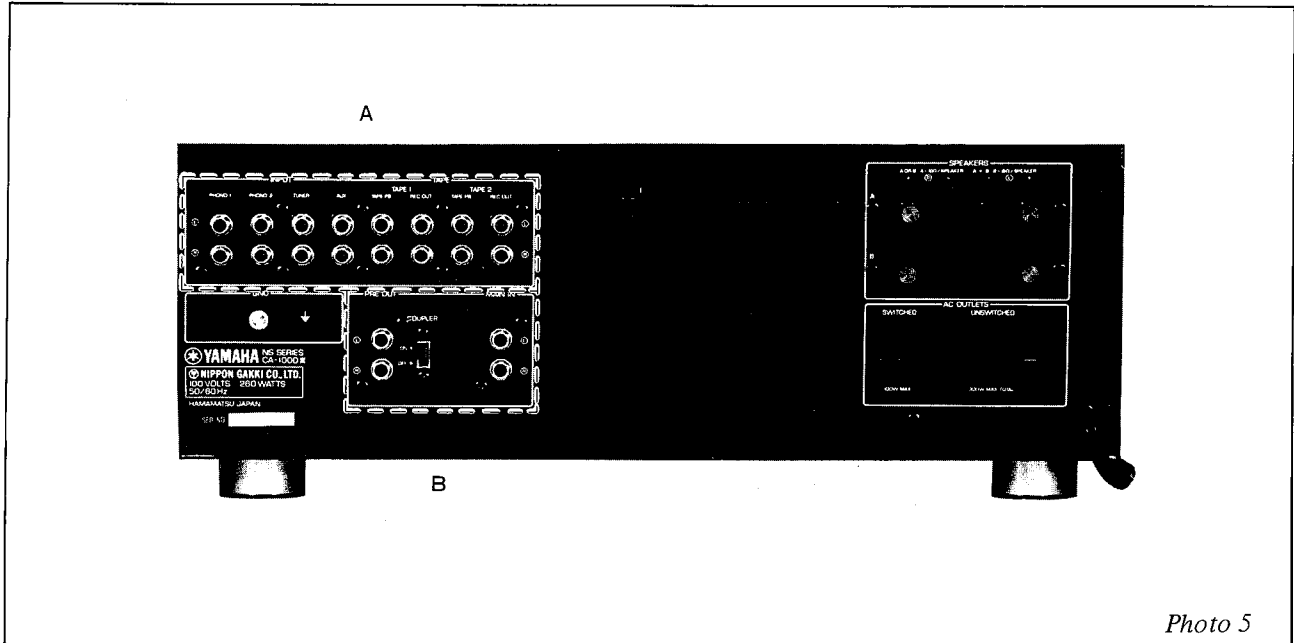

Photo 5

PHOTO 6 REMOVING THE FRONT PANEL

Remove all knobs with a hexagonal allen wrench provided. Then remove six screws from upper and lower surfaces shown below.

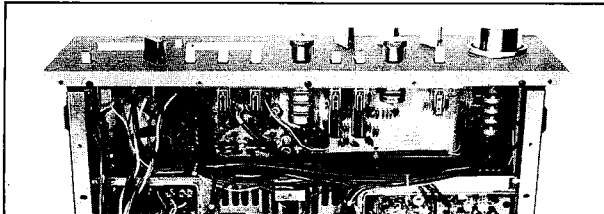

Photo 6

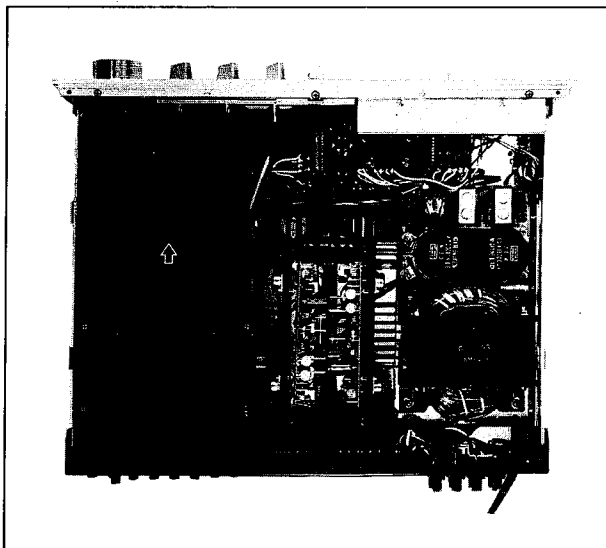

PHOTO 7 TILTING THE REAR PANEL

Remove screws 1 and 2 shown in Photo 6, loosen screws 3 to 6, and then remove the shield case by shifting the case in arrowed direction and by lifting it up.

Remove eight screws shown by arrow A in Photo 5, and lift up the pin jack from the rear panel.

Remove two upper screws (one on either side) shown in Photo 7, loosen two lower screws (one on either side), and then tilt the rear panel in arrowed direction.

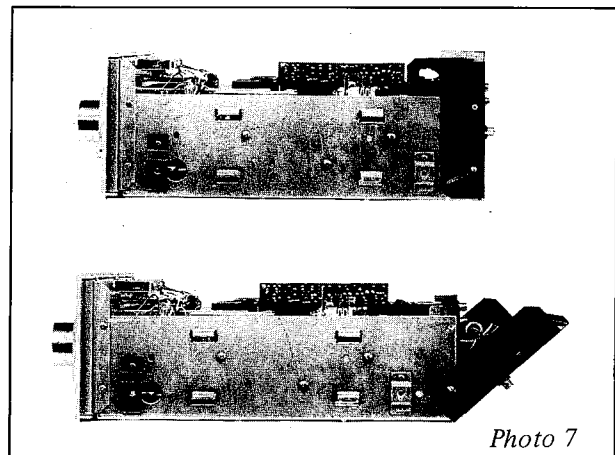

Photo 7



- Under this condition, LED and meters can be replaced.
- Note: LED is adhered to a hole of the panel.

DISASSEMBLY PROCEDURES

PHOTO 8 REMOVING THE METER C. BOARD

Remove two screws indicated by A, and remove the metal part fixing meter lamp c. board along with the c. board itself. Remove three screws indicated by B, and remove special hexagonal nut attaching the slide switch indicated by C.

- Under this condition, the power switch and head-phone jack can be dismantled after removing screws D and E. Also, the rotary switch for speaker selection can be removed after removing the special hexagonal nut indicated by C.

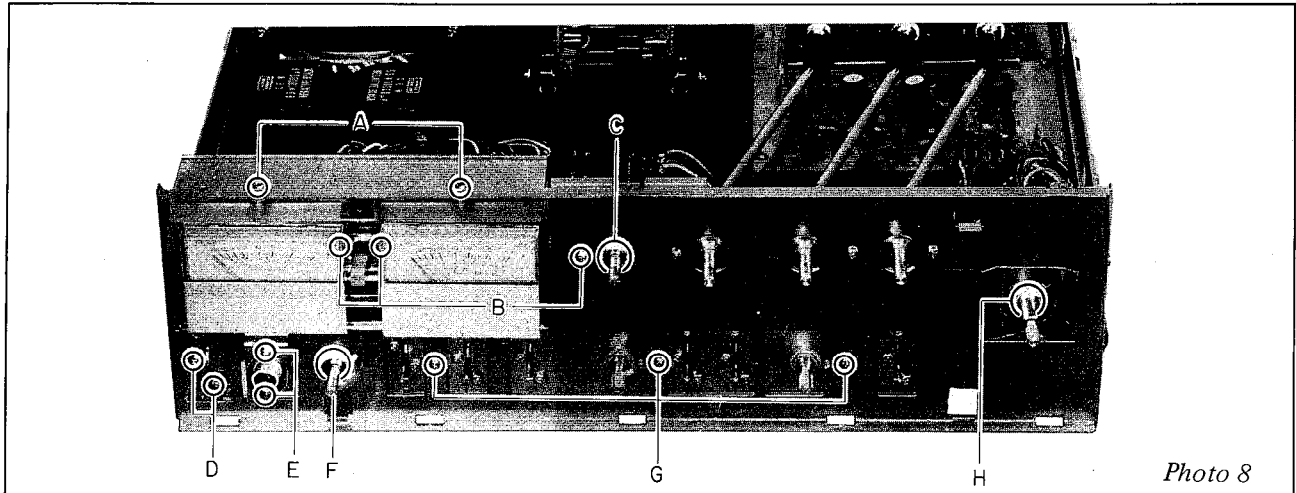

Photo 8

PHOTO 9 REMOVING THE FUNCTION C. BOARD

Remove screws 1 and 2 shown in Photo 6, loosen 3 to 6, and then remove the shield case by shifting the case in arrowed direction and by lifting it up. Remove eight screws shown by arrow A in Photo 5, and then separate the c. board from the rear panel. Withdraw the connecting rod in arrowed direction from the universal joint. Remove two lower screws shown by an arrow in Photo 9 and four screws already loosened, and then dismantle the function c. board completely.

PHOTO 10 REMOVING THE TONE CONTROL C. BOARD

Remove the sub-panel from the side frame by removing four screws on both sides shown below. Remove three screws G and one special hexagonal nut H shown in Photo 8, and then dismantle the tone control c. board completely.

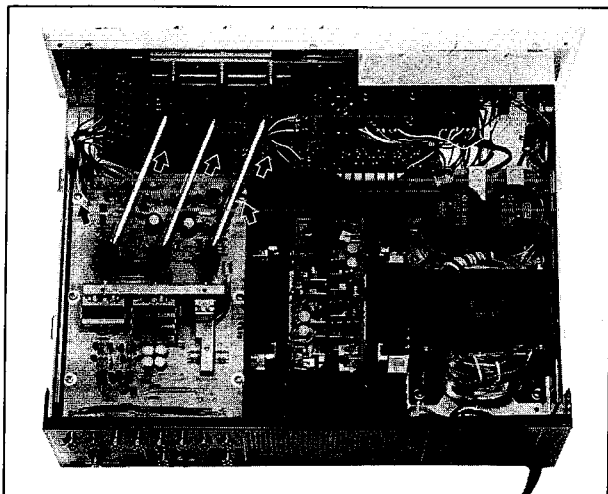

Photo 9

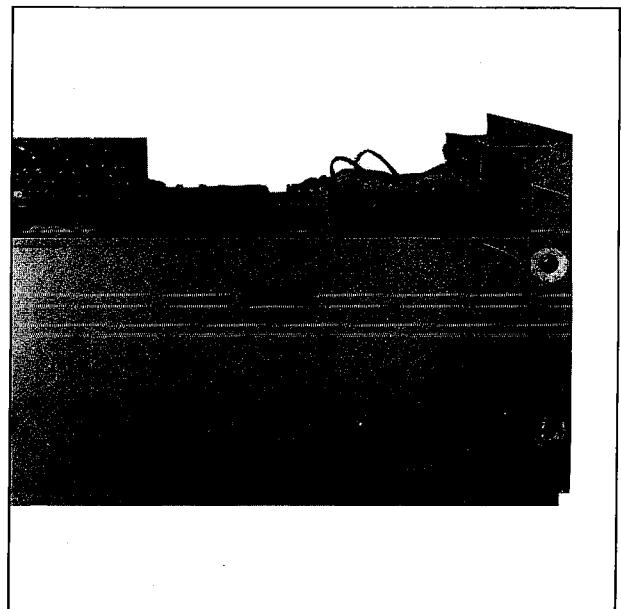

Photo 10

DISASSEMBLY PROCEDURES

PHOTO 11 REMOVING THE MAIN C. BOARD

By removing four screws shown in Photo-A, remove the MAIN c. board along with the heat sink from the main chassis. At this time, when the coupler c. board is removed as instructed in Photo 5, the MAIN c. board can be sufficiently lifted up because of ample wiring margin.

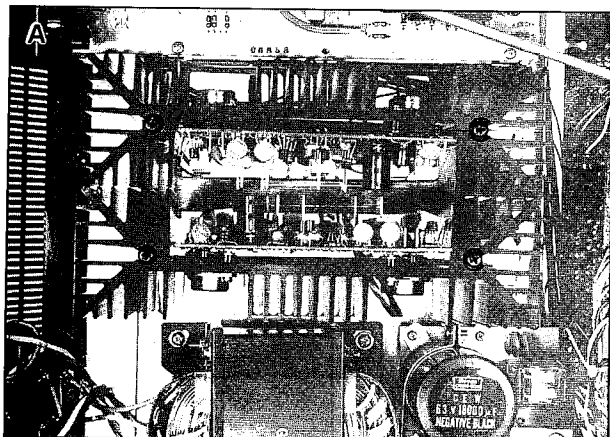

Photo 11

- By removing eight screws fixing the power transistor shown in Photo-B, dismantle the MAIN c. board and power transistor simultaneously from the heat sink.

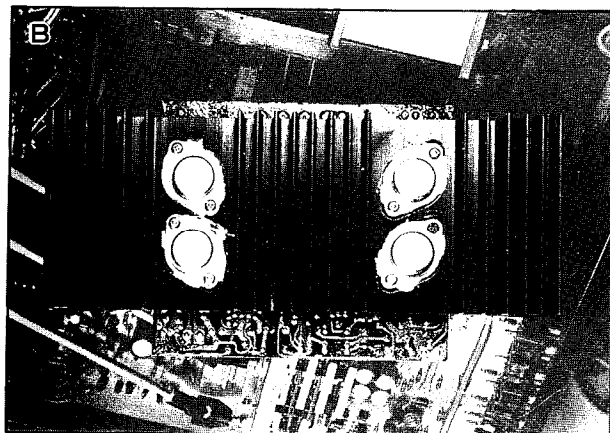

Photo 11

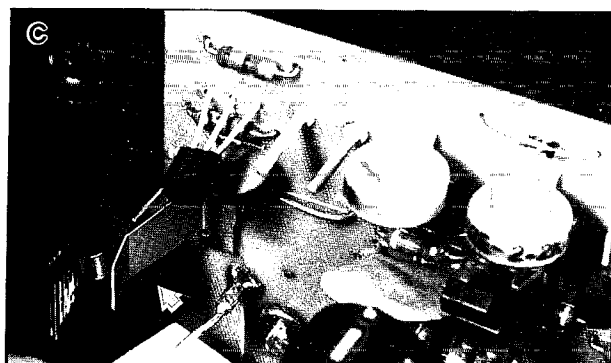

Photo 11

PHOTO 12 REMOVING THE ELECTROLYTIC C. BOARD AND POWER-TRANSFORMER.

Remove four screws.

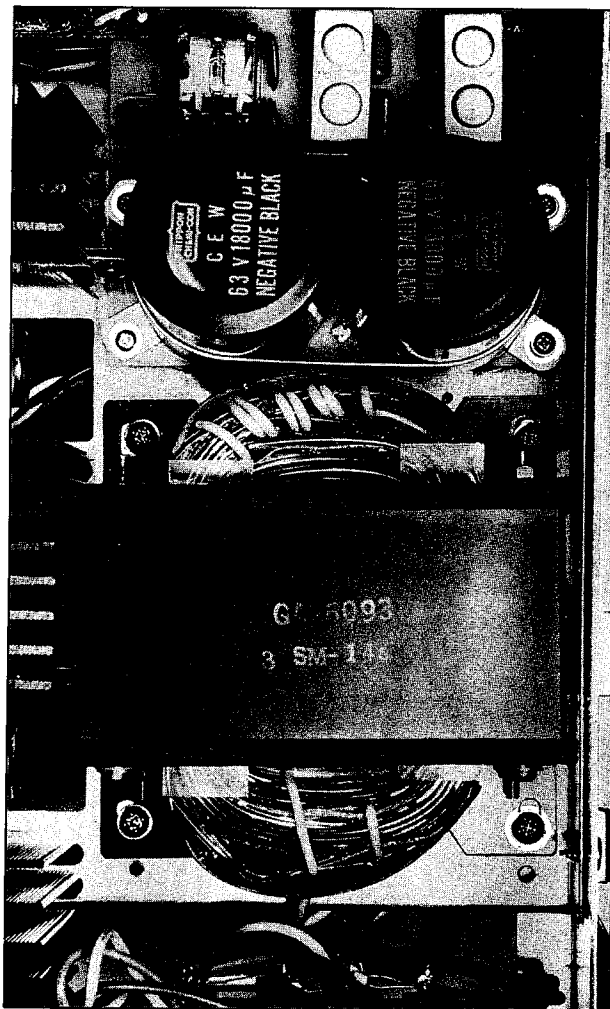
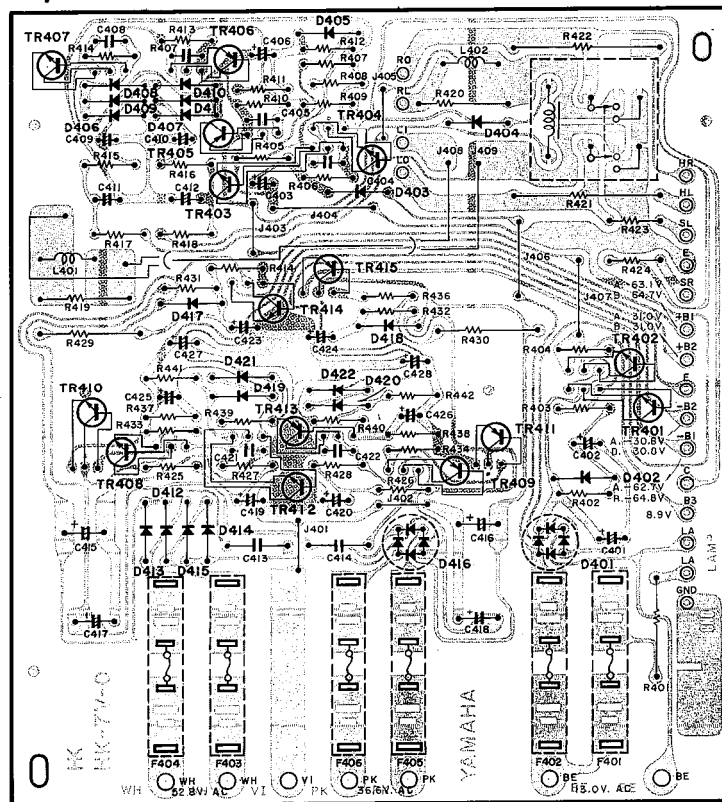
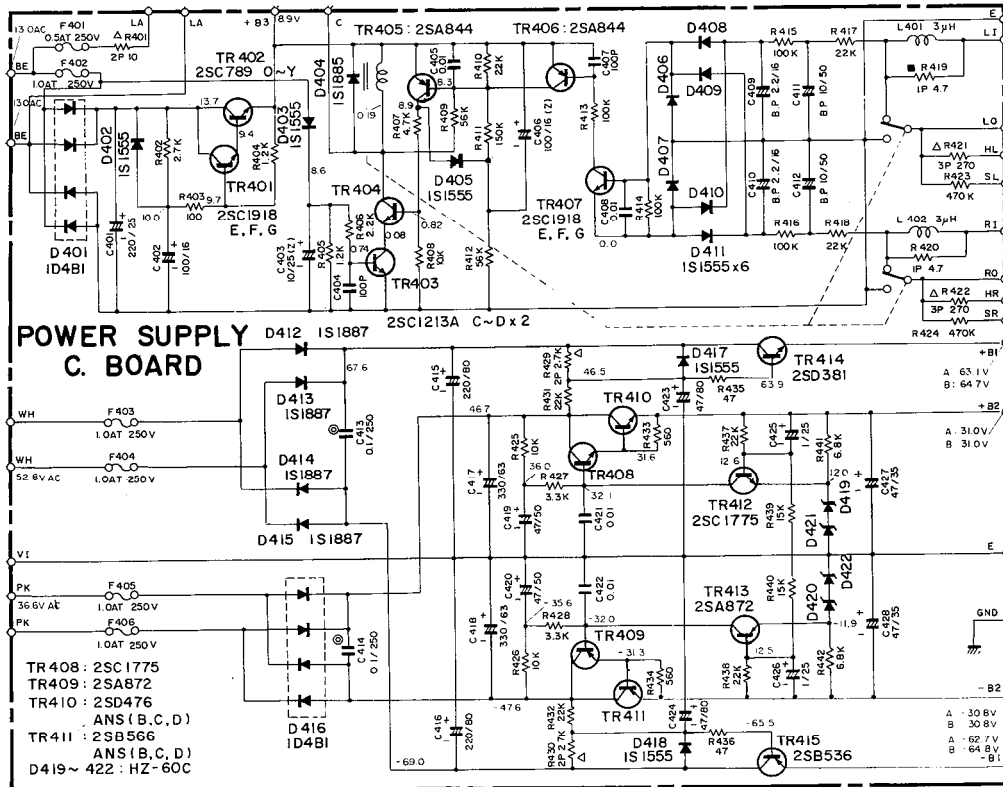

Photo 12

- Temperature compensating transistor is shown by an arrow in Photo-C. When the MAIN c. board is assembled, pay attention to heat coupling between the MAIN c. board and heat sink. Also, when the power transistor is replaced, pay attention to insulation and heat coupling with the heat sink.

PRINTED CIRCUIT BOARDS

POWER SUPPLY CIRCUIT BOARD



PRINTED CIRCUIT BOARDS

ELECTROLITIC CAPACITOR CIRCUIT BOARD

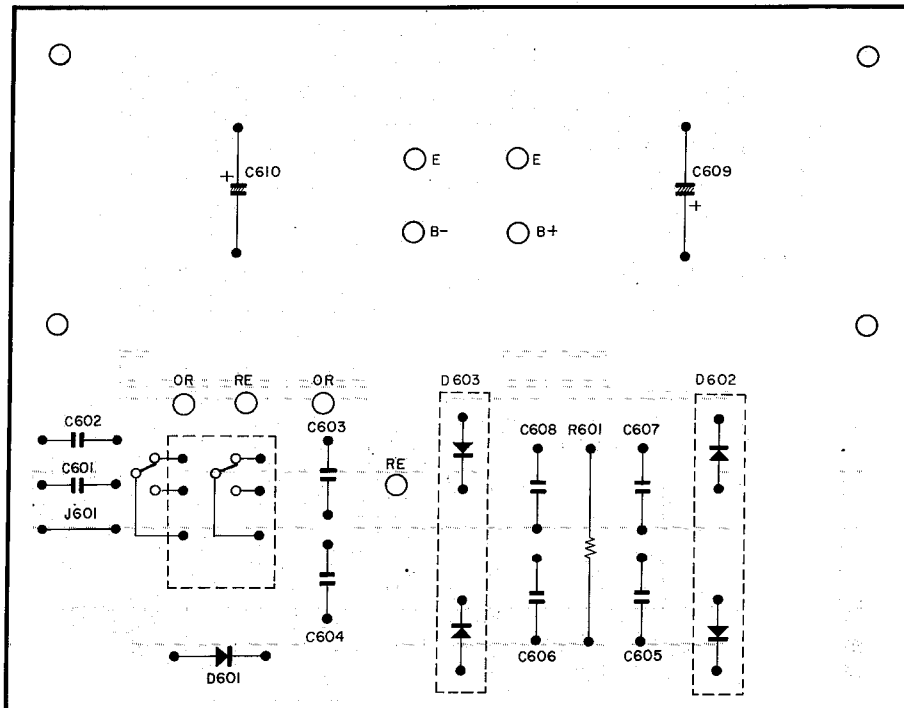
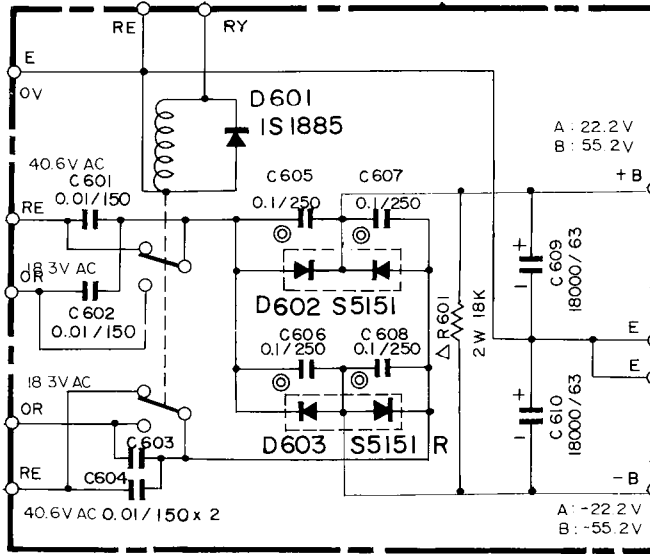

PRINTED CIRCUIT BOARDS

FUNCTION CIRCUIT BOARD

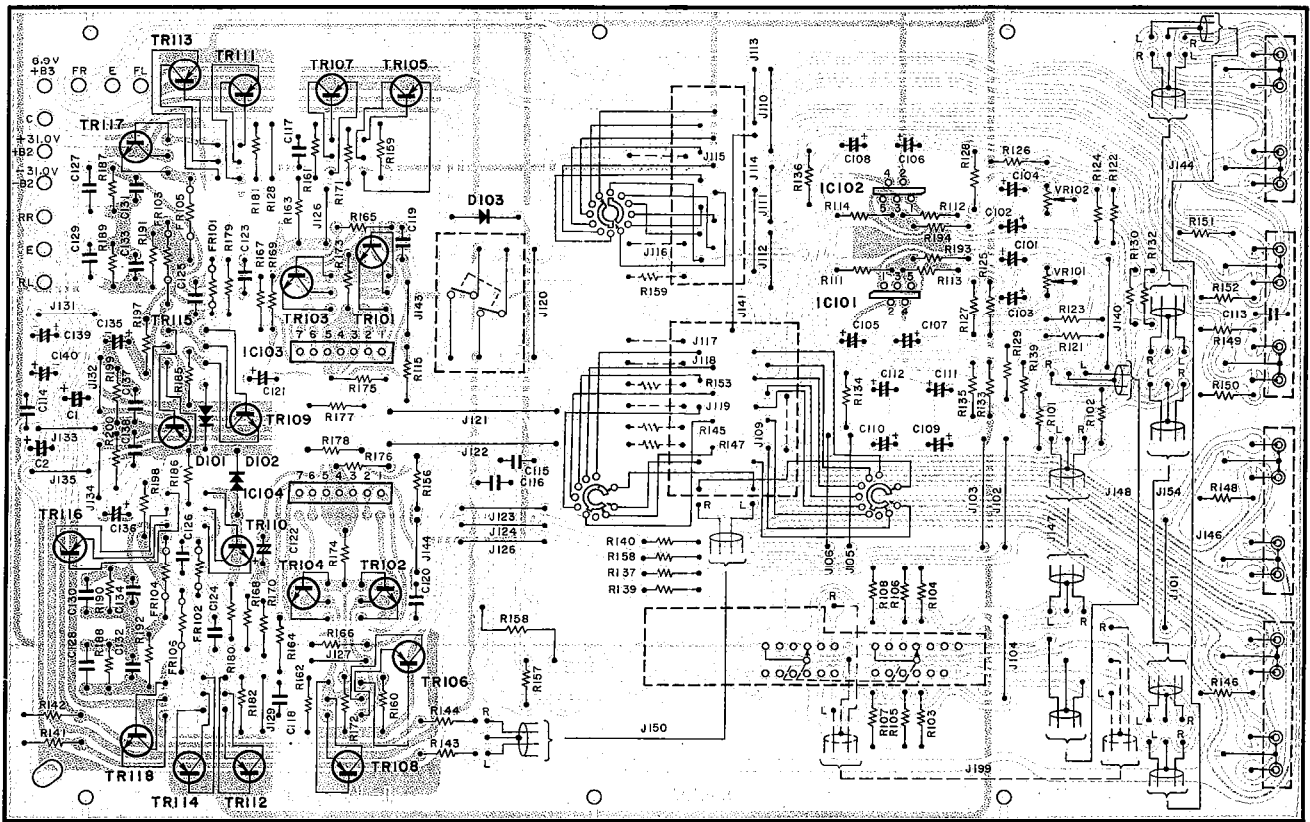
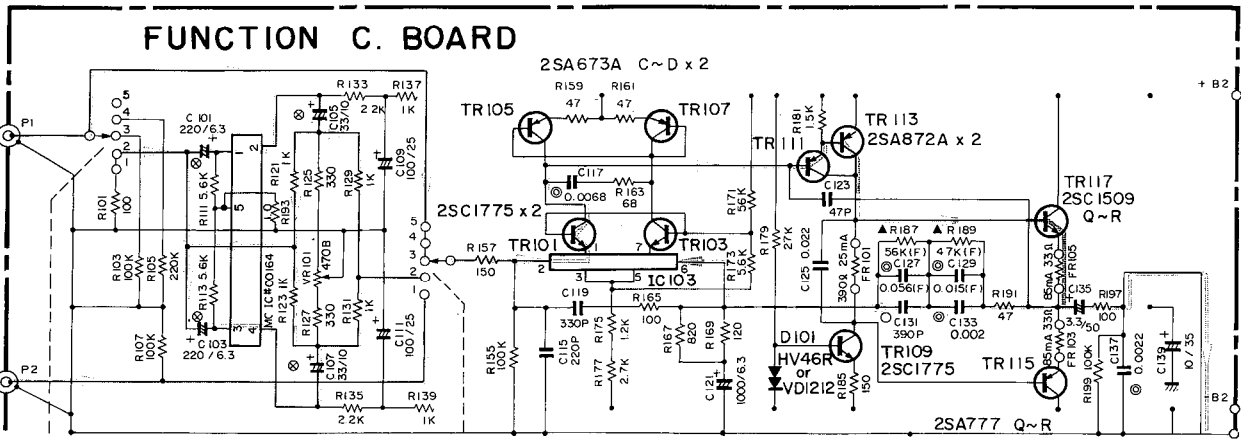

METER LAMP CIRCUIT BOARD

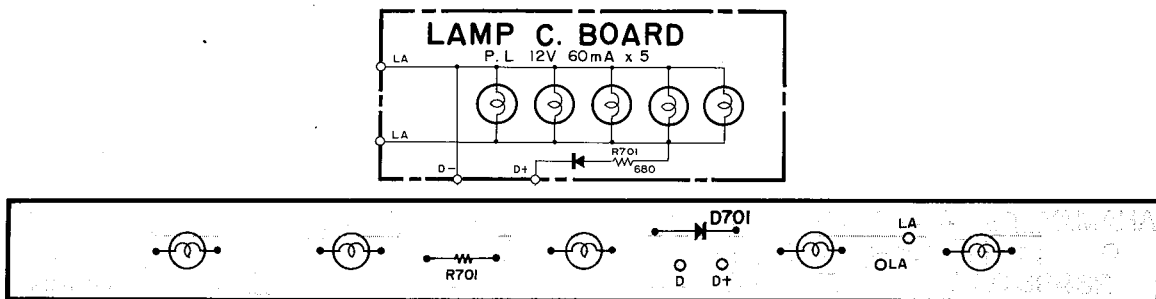

PRINTED CIRCUIT BOARDS

STONE CONTROL CIRCUIT BOARD

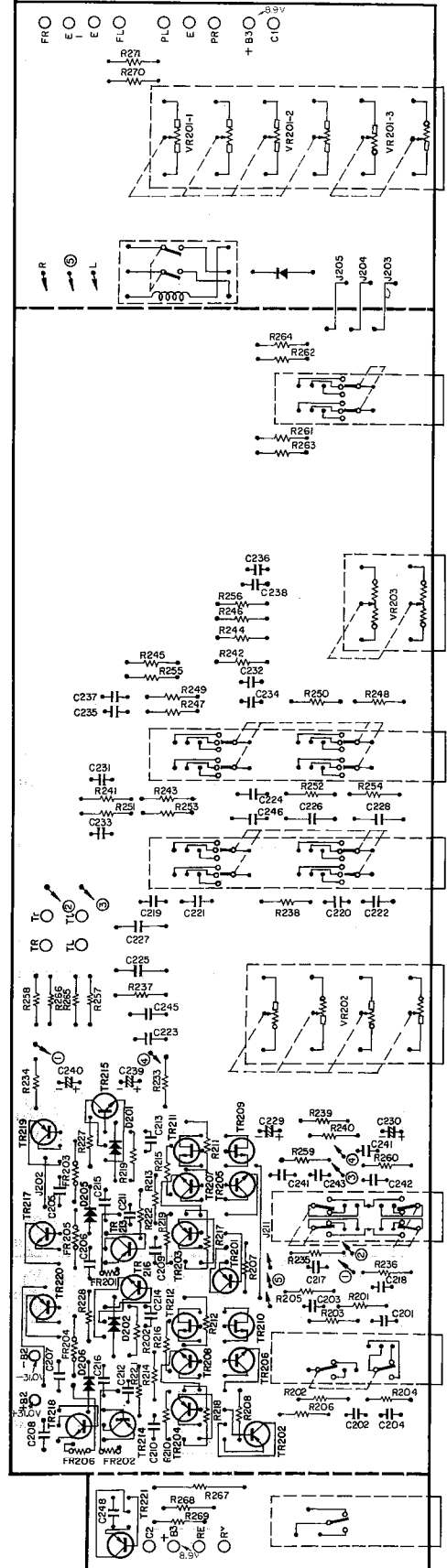
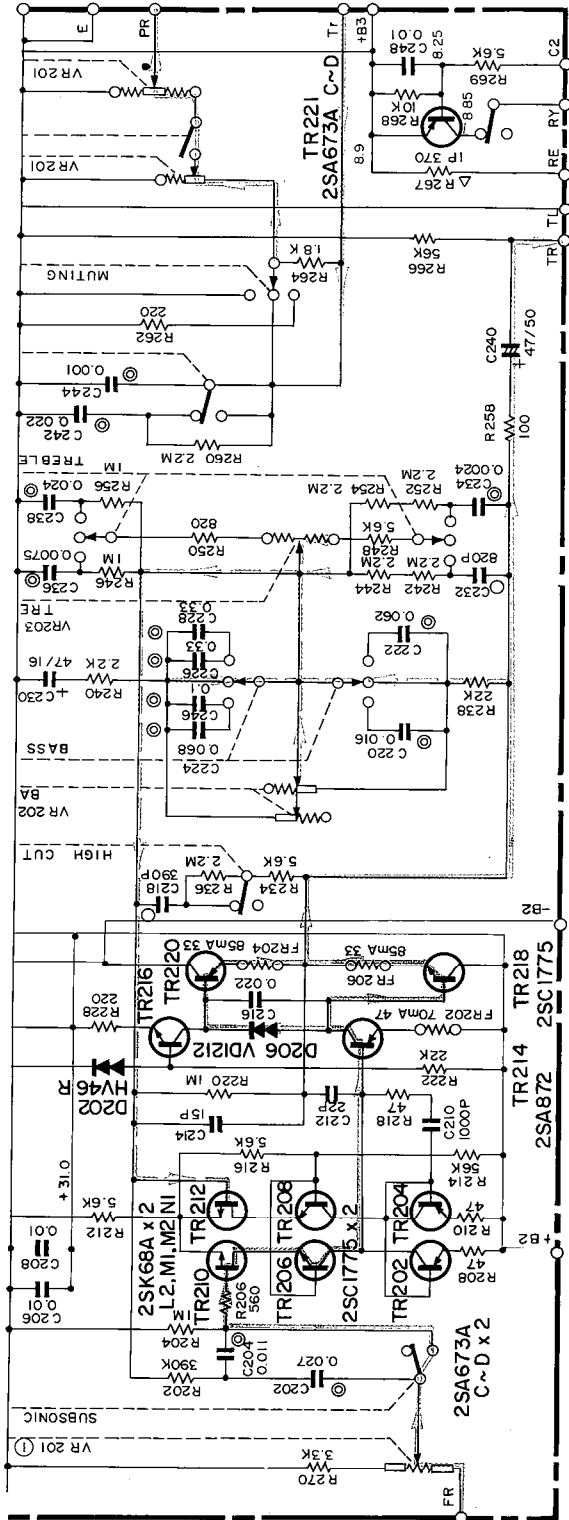

PRINTED CIRCUIT BOARDS

MAIN CIRCUIT BOARD

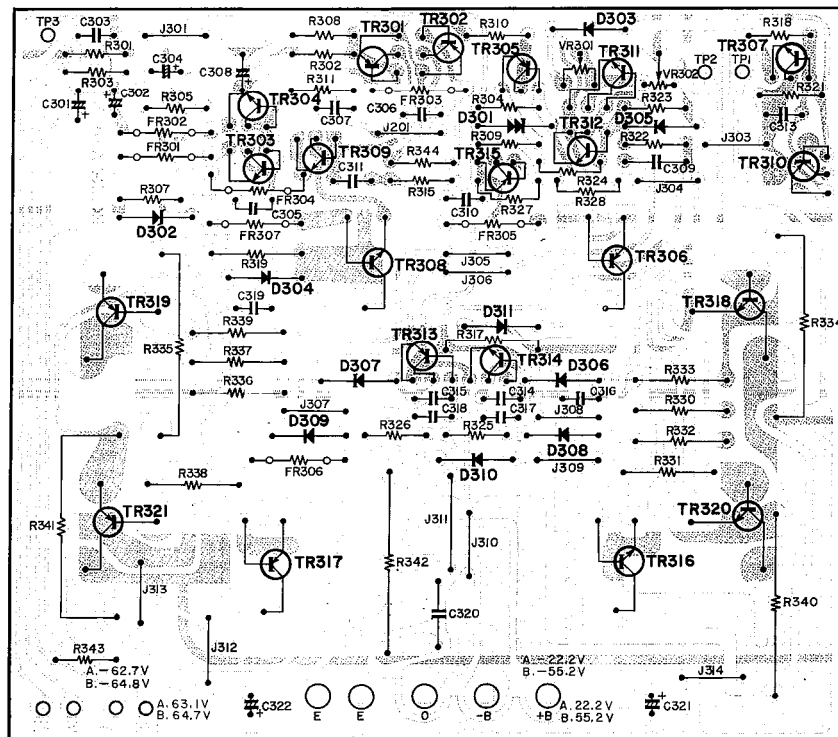
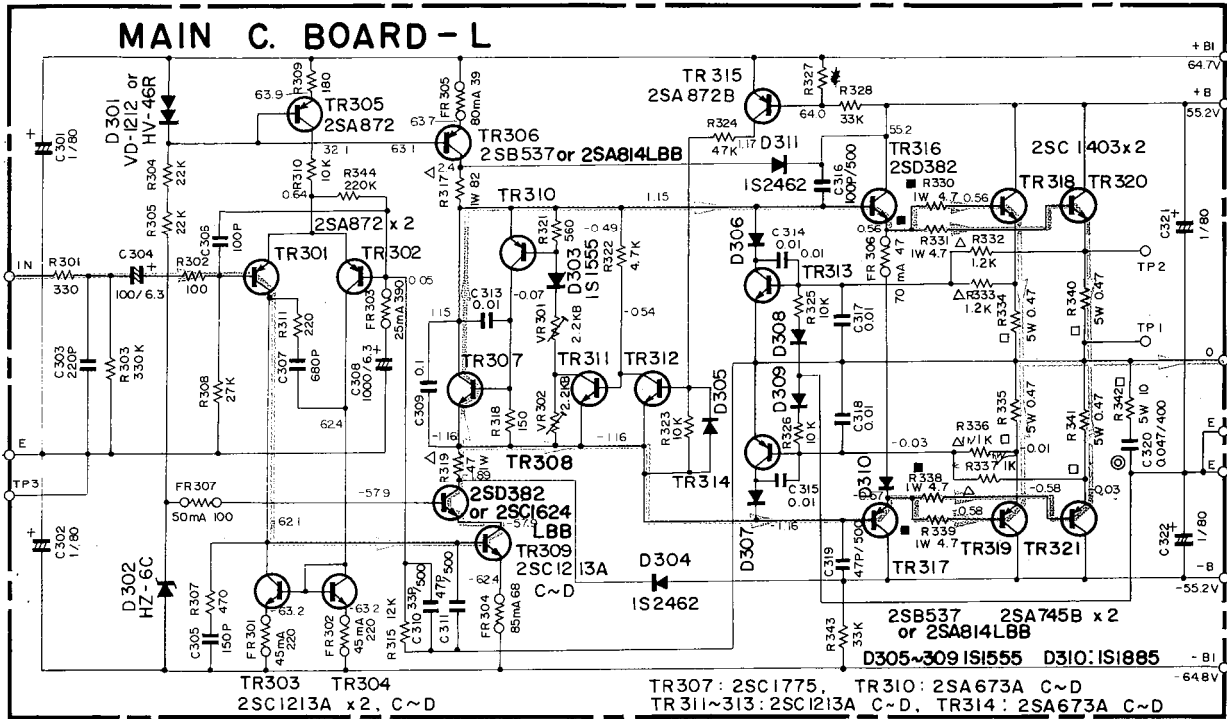

PRINTED CIRCUIT BOARDS

METER CIRCUIT BOARD

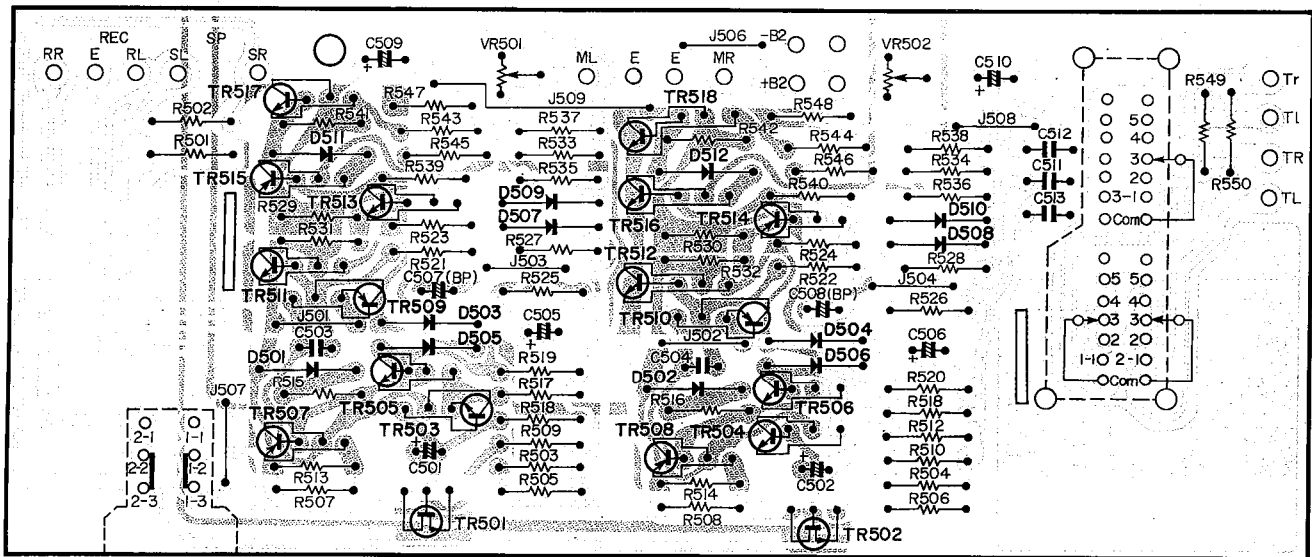
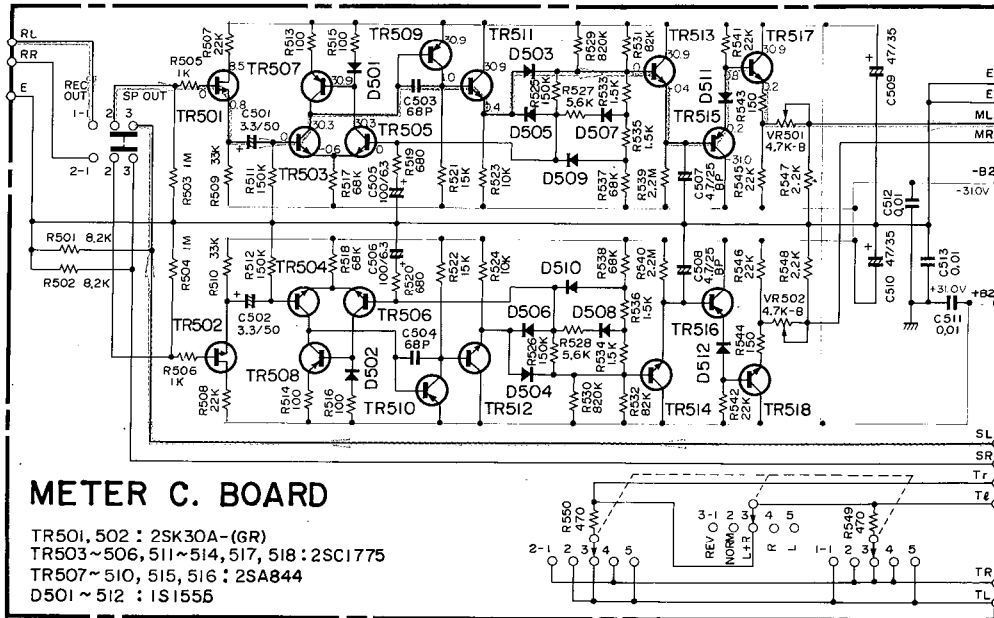

COUPLER CIRCUIT BOARD

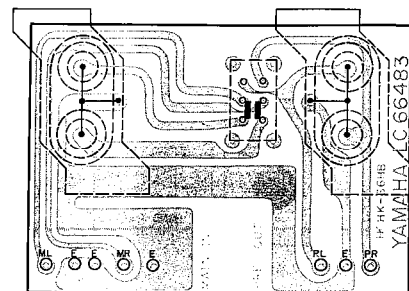
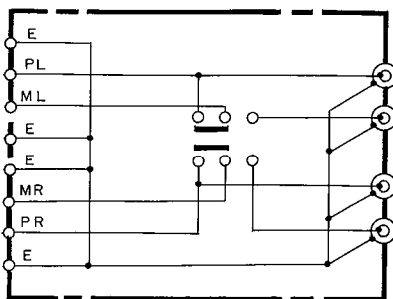

ADJUSTMENT

ADJUSTING POINTS:

- | | |
|--------------------------------|--|
| 1. Function C. Board | MC head amp performance (balancing) adjustment, VR101, 102 |
| 2. Meter C. Board | 0dB calibration, VR501, 502 |
| 3. Main C. Board | Operational point adjustment, VR301, 302 |

1. FUNCTION C. BOARD ADJUSTMENT (VR101, 102)

This adjustment is intended to balance the performance of the MC head amp. In general, the adjustment requires spectrum analyzer or 40kHz band pass filter and VTVM. Or the adjustment can be made by means of a distortion meter. If these instruments are not available, do not touch VR101 and 102.

ADJUSTING METHOD

Supply 20kHz, 3Vrms to the input terminal, and adjust VR101 and VR102 so that secondary higher harmonic wave at 40kHz is lowered to the lowest level. When the distortion meter is used, adjust so that distortion at 20kHz is minimized.

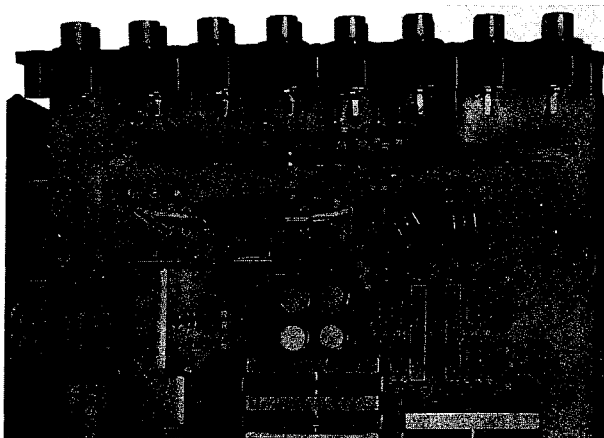

- INPUT: PHONO
- PHONO SELECTOR - MC
- OUTPUT: REC OUT
- REC OUT SELECTOR - PHONO

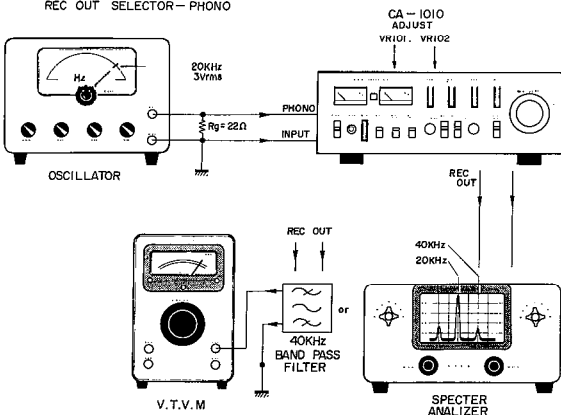

2. METER C. BOARD ADJUSTMENT (VR501, 502)

Adjusting Method

Connect a dummy resistance of 8Ω and 100W or more to the output terminal, and supply 1kHz signal to the input terminal. When the output becomes 100W (VTVM voltage: 28.28 Vrms), adjust VR501 and VR502 so that the meter reads 0dB.

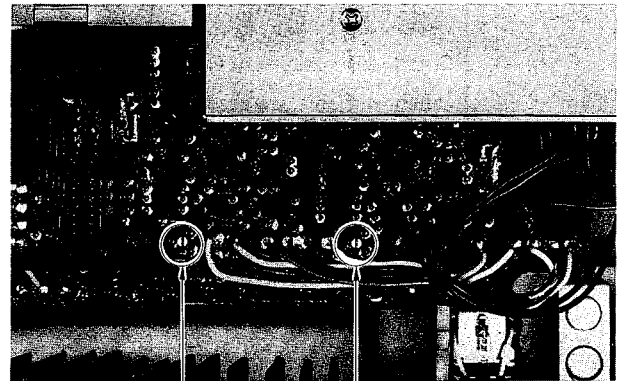

VR501 VR502

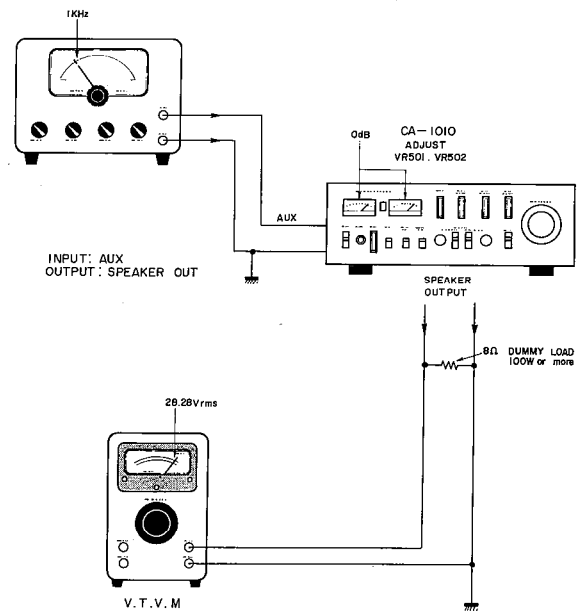

ADJUSTMENT

3. MAIN C. BOARD ADJUSTMENT (VR301, 302, BOTH CHANNELS)

The main c. board is adjusted in terms of idling current of A-class and B-class (NORMAL). By turning the OPERATION switch, VR302 is short-circuited or actuated through transistor switching function. Therefore, be sure to set the OPERATION switch to B-class (NORMAL), and then adjust VR301.

ADJUSTING METHOD

Turn off the COUPLER switch on the rear side so as not to supply signal to the main c. board. Connect a dummy resistance of 8Ω to the output terminal, connect VTVM to TP2(+) and TP1(-), and adjust so that voltage between terminals becomes the following values:

NORMAL 25mV (VR301)
A-class 280mV (VR302)

- This adjustment is made by repeating several times in the sequence of Lch (NORMAL \rightarrow A-class) \rightarrow Rch (NORMAL \rightarrow A-class).

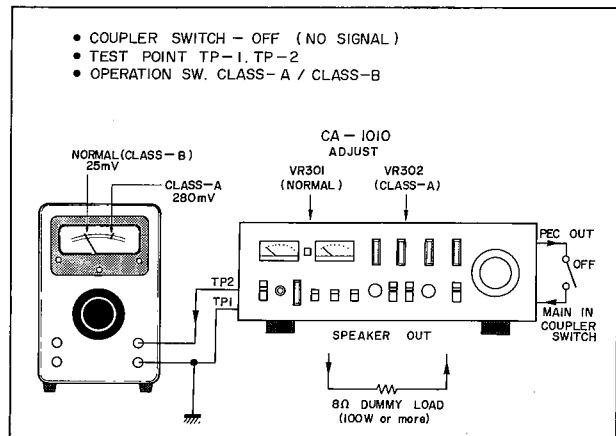
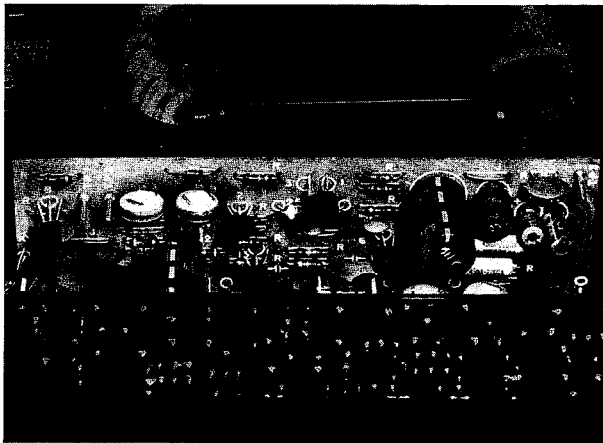

SCHEMATIC DIAGRAM BY EXPORT ZONE

■ For general export models, refer to the schematic diagram.

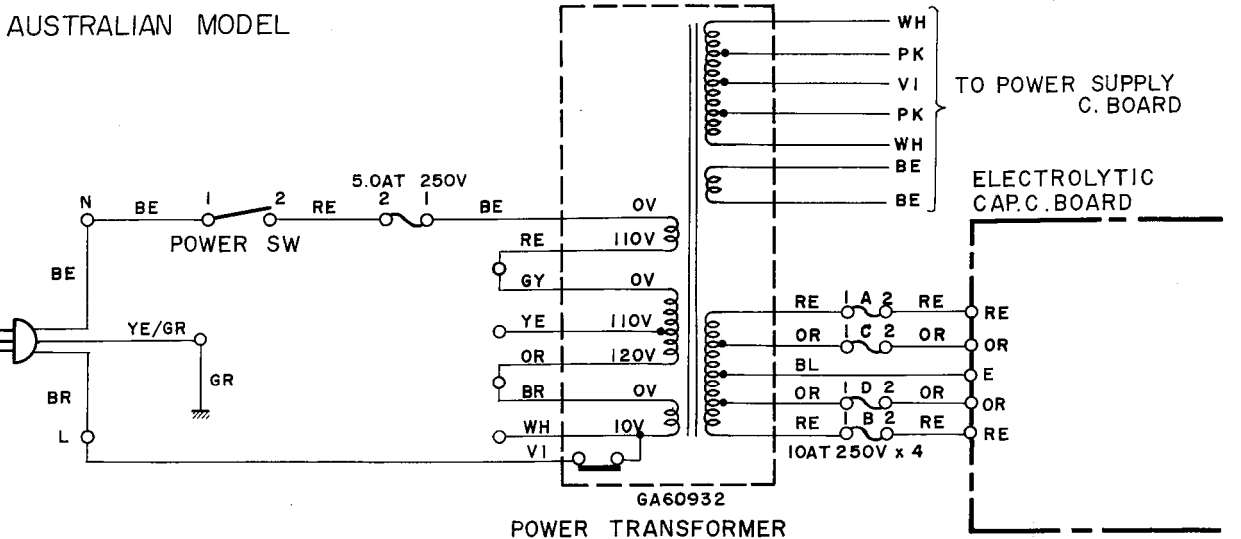
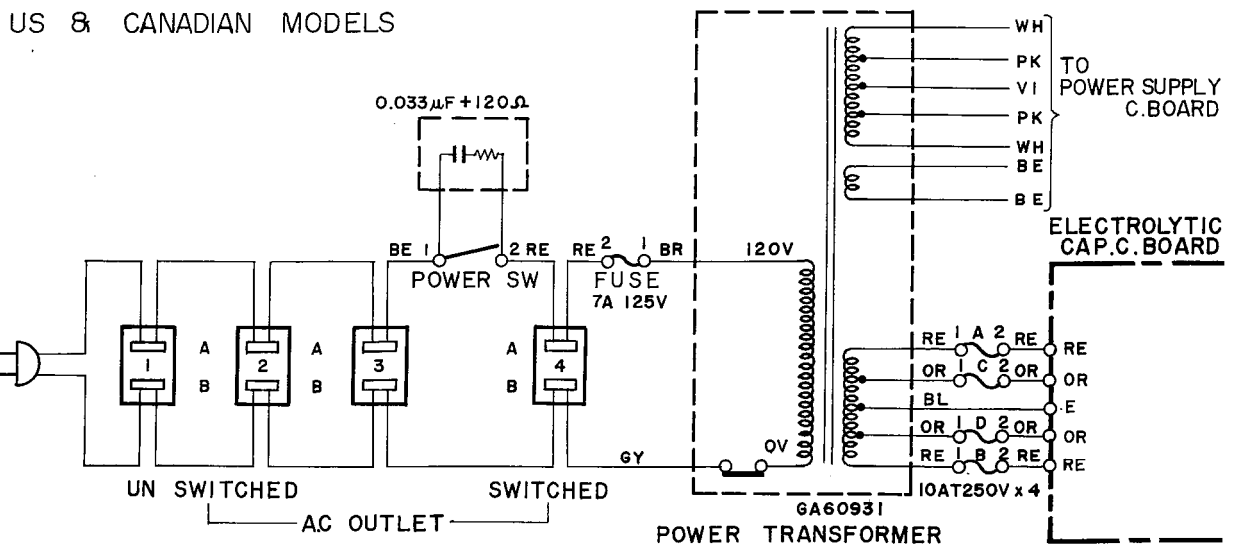
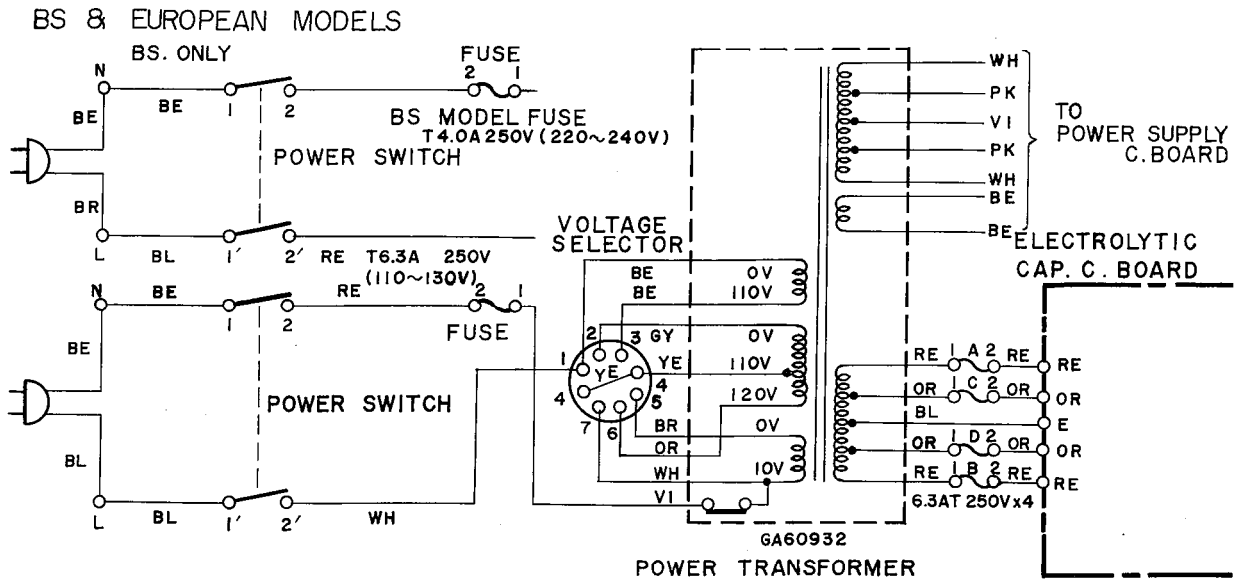

PACKAGE

